



smart

INVERTER WÄRMEPUMPE PLUS - GEWERBLICH **BEDIENUNGSANLEITUNG**

INVERTER HEAT PUMP
PLUS - COMMERCIAL
OPERATION MANUAL

PERAQUA®

pooled family pleasure

PERAQUA Professional Water Products GmbH

Handelsstraße 8, 4300 St. Valentin

Tel. +43 7435 58 488-0

info@peraqua.com



WWW.PERAQUA.COM



MEMBER OF **PRAHER**
GROUP



SMART POOL TECHNOLOGY made in Austria



PERAPLAS Deutschland GmbH

Regensburger Ring 12, 91154 Roth - DE

Tel. +49 9171 96771200

office.de@peraplas.com



CHEMIA BRUGG



CHEMIA BRUGG AG

Aarauerstrasse 51, 5200 Brugg - CH

Tel. +41 56 460 62 60

info@chemia.ch





INSTALLATION AND USER MANUAL

Thank you for choosing Full-inverter pool heat pump.

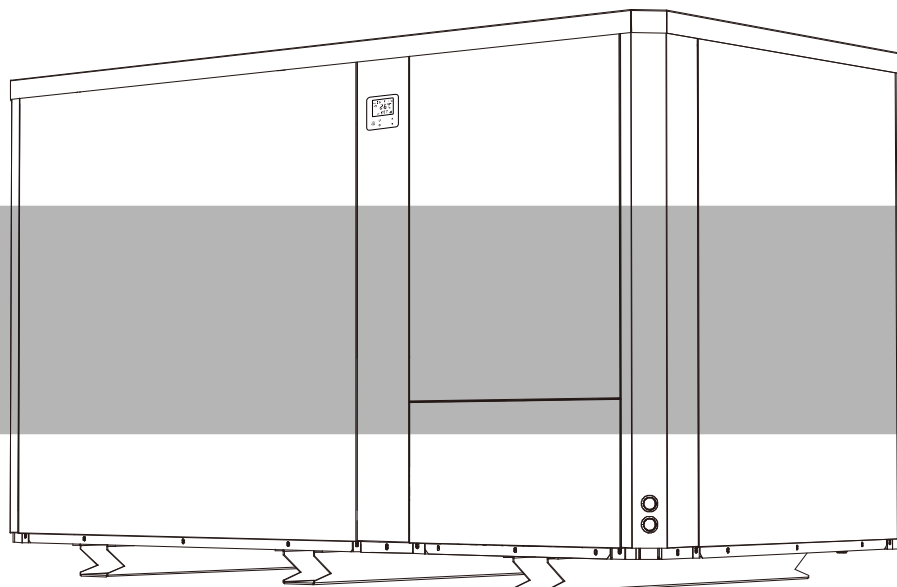

SUMMARY

For users *P.1-P.7*

1. GENERAL INFORMATION 1

1.1. Contents: 1

1.2. Operating conditions and range: 1

1.3. Advantages of different modes: 1

1.4. Kind reminder:.....	2
2. OPERATIONS	4
2.1. Notice before using.....	4
2.2. Operation instructions.....	5
2.3. Daily maintenance and winterizing	7
3. TECHNICAL SPECIFICATION	8
<i>For installers and professionals P.8-P.18</i>	
1. TRANSPORTATION.....	10
2. INSTALLATION AND MAINTENANCE.....	11
2.1. Notice before installation:	11
2.2. Installation instruction.....	12
2.3. Trial after installation	17
2.4. Maintenance and winterizing.....	18
3. TROUBLE SHOOTING FOR COMMON FAULTS.....	19
4. Failure code.....	20
APPENDIX 1: HEATING PRIORITY WIRING DIAGRAM (OPTIONAL)	22
5. WIFI SETTING	24

1. GENERAL INFORMATION

1.1. Contents:

After unpacking, please check if you have all the following components.

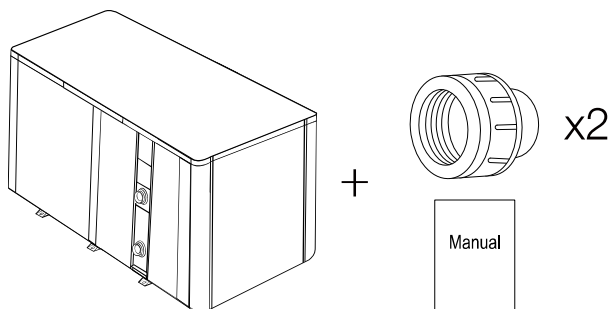

1.2. Operating conditions and range:

ITEMS		RANGE
Operating range	Air temp	-7°C~43°C
Temp. setting	heating	18°C~35°C

The heat pump will have ideal performance in the operation range Air 15°C~25°C.

1.3. Advantages of different modes:

The heat pump has two modes: Smart and Silence. They have different advantages under different conditions.

MODE	RECOMMENDATION	ADVANTAGES
Smart mode 	As standard	Heating capacity: 20% to 100% capacity Intelligent optimization

1.4.		Fast heating	Kind
	Silence mode 	Use at night	

reminder:

 **This heat pump has Power-off memory function. When the power is recovered, the heat pump will restart automatically.**

1.4.1. The heat pump can only be used to heat the pool water. **It can NEVER** be used to heat other flammable or turbid liquid.

1.4.2. Don't lift the water union when moving the heat pump since the titanium heat exchanger inside the heat pump will be damaged.

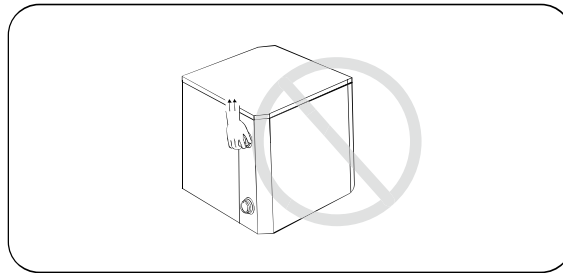

1.4.3. Don't put obstacles before the air inlet and outlet of the heat pump.

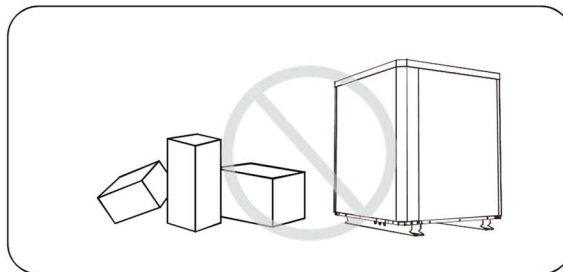

1.4.4. Don't put anything into inlet or outlet, or the efficiency of the heat pump will be reduced or even stopped.

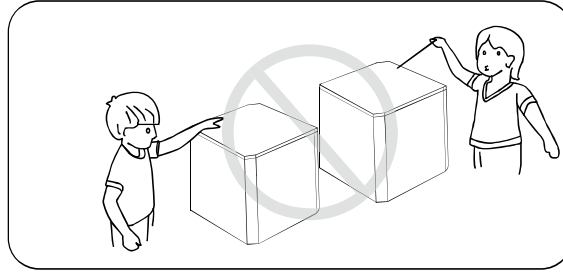

1.4.5. Don't use or store combustible gas or liquid such as thinners, paint and fuel to avoid fire.

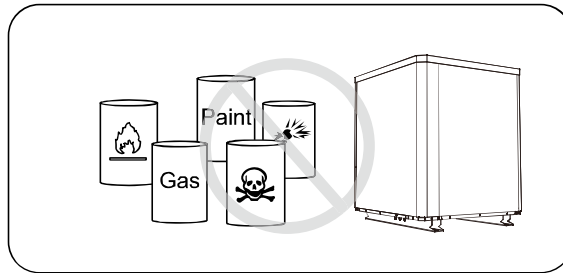

1.4.6. If any abnormal circumstances occurred, **e.g.: abnormal noises, smells, smokes and leakage of electricity, switch off the main power immediately and contact your local dealer.** Don't try to repair the heat pump by yourselves.

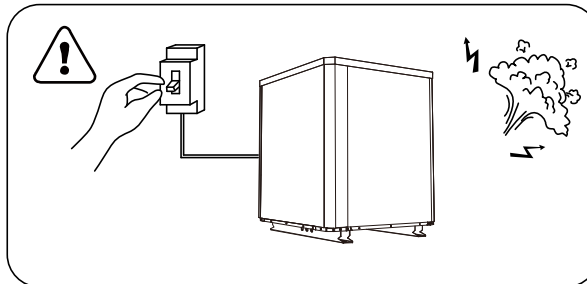

1.4.7. The main power switch should be out of the reach of Children.

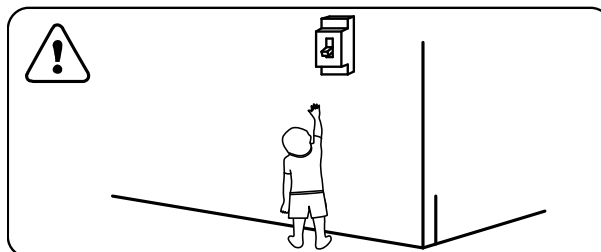

1.4.8. Please cut off the power in the lightning storm weather.

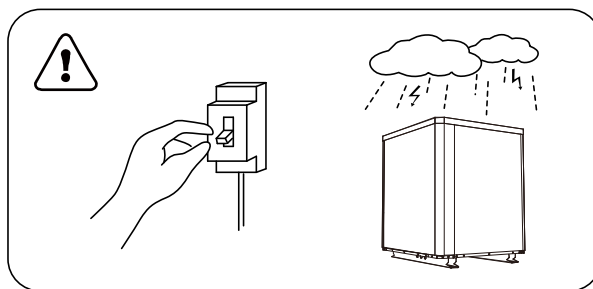

1.4.9. Please note that following codes are not failure.

	CODES
No water flow	E3
Anti-Freezing Reminder	Ed
Out of the operating range	Eb
Insufficient water flow or pump blocked	E6
Power abnormal	E5





2. OPERATIONS

2.1. Notice before using

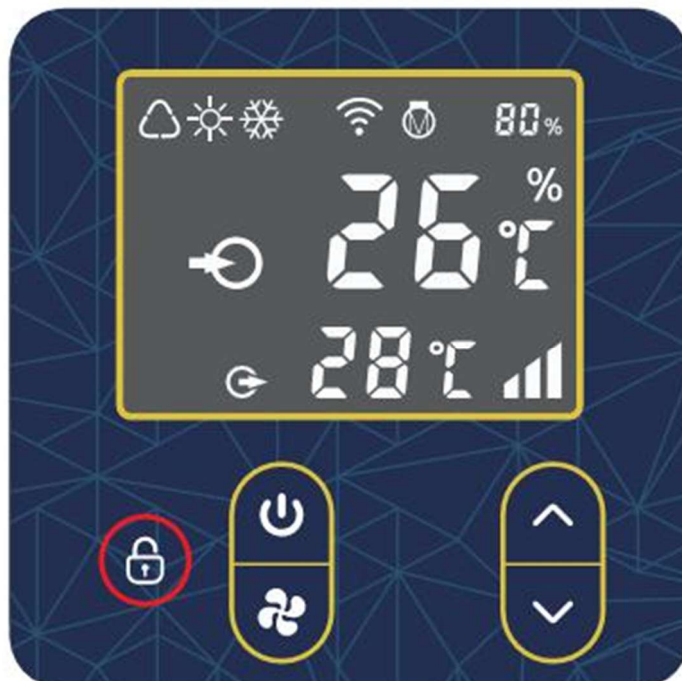
- 2.1.1. For longer service life, please ensure water pump is on before heat pump starts to work, and water pump is off after heat pump is off.
- 2.1.2. Ensure no water leakage on piping system, then unlock screen and press  to power on heat pump.

2.2. Operation instructions



SYMBOL	DESIGNATION	FUNCTION
	ON/OFF	Power On/Off
	Unlock	Press it for 3 seconds to unlock/lock screen
	Speed	Select Smart/Silence mode
	Up / Down	Adjust set temperature

Note:

- ① Screen lock:
 - a. If no operation in 30 seconds, screen will be locked.
 - b. When HP is off, screen will be dark and "0%" will be displayed.

FOR USER





c. Press  for 3 seconds to lock screen and it will be dark

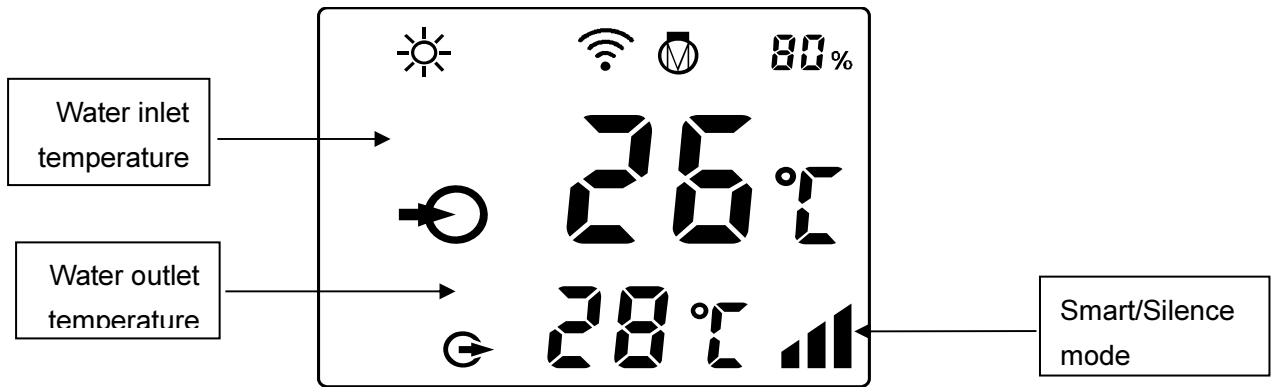

② Screen unlock:

a. Press  for 3 seconds to unlock screen and it will be lit up.

b. Only after screen is unlocked, any other buttons can be functioned.





	Heating
 80%	Heating capacity percentage
	Wifi connection
	Water inlet
	Water outlet

1.Power On: Press  for 3 seconds to light up screen, then press  to power on heat pump.

2.Adjust Set Temperature: When screen is unlocked, press  or  to display or adjust the set temperature.

3. Smart/Silence mode selection:





① Smart mode as default will be activated when heat pump is on, and screen shows .

② Press  to enter Silence mode, and screen shows .

(Suggestion: select Smart mode for initial heating.)

4. Defrosting

a. Auto Defrosting: When heat pump is defrosting,  will be flashing. After defrosting,  will stop flashing.

b. Compulsory Defrosting: When heat pump is heating, press  and  together for 5 seconds to start compulsory defrosting, and  will be flashing. After defrosting,  will stop flashing.

(Note: Compulsory defrosting intervals should be more than 30 minutes and the compressor should run for more than 10 minutes.)

5. Wifi setting

Please kindly check the last page.

2.3. Daily maintenance and winterizing

2.3.1. Daily Maintenance

 **Please don't forget to cut off power supply of the heat pump**

- Please clean the evaporator with household detergents or clean water, NEVER use gasoline, thinners or any similar fuel.
- Check bolts, cables and connections regularly.

2.3.2. Winterizing

FOR USER

In winter season when you don't swim, please cut off power supply and drain water out of the heat pump. When using the heat pump under 2°C, make sure there is always water flow.

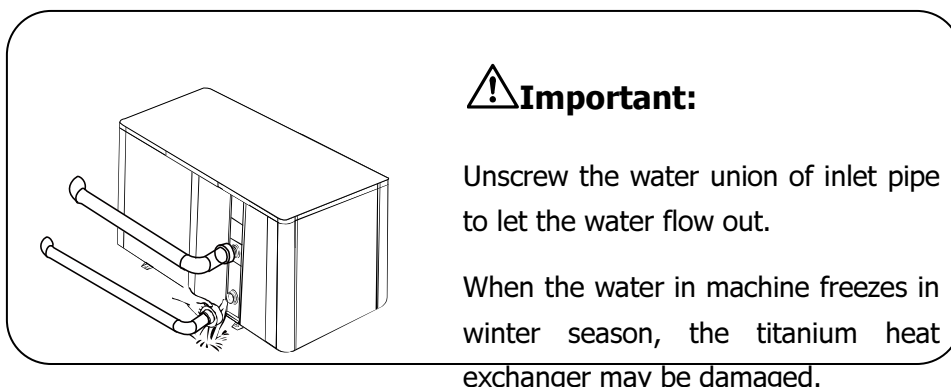

3. TECHNICAL SPECIFICATION

Model	7300720	7300721
Advised pool volume (m ³)	130~260	260~520
Operating air temperature (°C)	-7~43	
Performance Condition: Air 26°C, Water 26°C, Humidity 80%		
Heating capacity (kW)	59.6	109.0
COP at 50% capacity	10.0	9.8
Performance Condition: Air 15°C, Water 26°C, Humidity 70%		
Heating capacity (kW)	39.4	80.5
COP at 50% capacity	6.7	6.6
Sound pressure at 1m dB(A)	54.0~62.0	56.0~65.0

FOR USER

Sound pressure of 50% capacity at 1m dB(A)	56.0	58.0
Sound pressure at 10m dB(A)	34.0~42.0	36.0~45.0
Compressor	DC inverter	
Heat exchanger	Spiral titanium tube in PVC	
Casing	Metal	
Fan direction	Vertical	
Power supply	400V/3Ph/50Hz	
Rated input power at air 15°C (kW)	2.20~8.03	4.69~17.9
Rated input current at air 15°C (A)	3.17~11.59	6.77~25.8
Advised water flux (m ³ /h)	20~25	40~50
Water pipe in-out size (mm)	75	110
Net dimension LxWxH (mm)	1000x1110x1260	2100x1090x1280
Net weight (kg)	212	459

- *The values indicated are valid under ideal conditions: Pool covered with an isothermal cover; filtration system running at least 15 hours per day.*
- *Related parameters are subject to adjustment periodically for technical improvement without further notice. For details please refer to nameplate.*

1. TRANSPORTATION

1.1. When storing or moving the heat pump, the heat pump should be at the upright position.

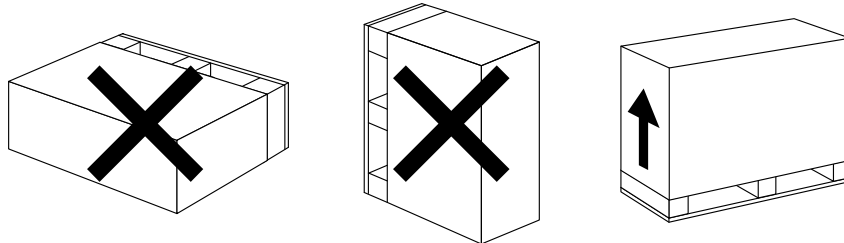

1.2. When moving the heat pump, do not lift the water union since the titanium heat exchanger inside the heat pump will be damaged.

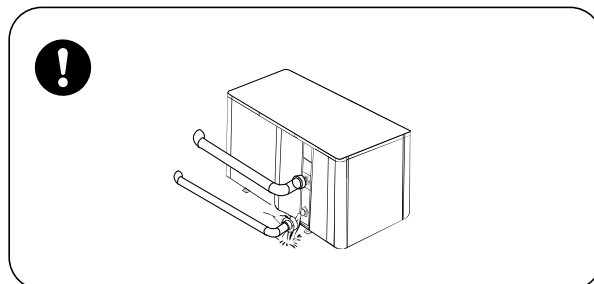

1.3. Before moving the Commercial inverter, remove the screws which fixed on the pallet and remove the pallet.

1. Remove the screws which fixed on the pallet

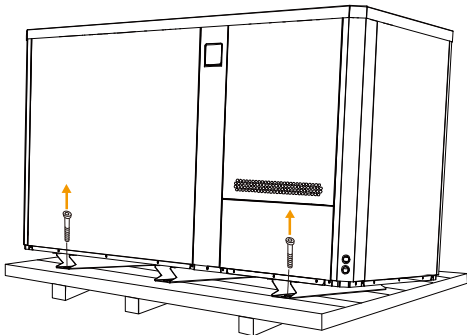

2. Deliver with fork lift

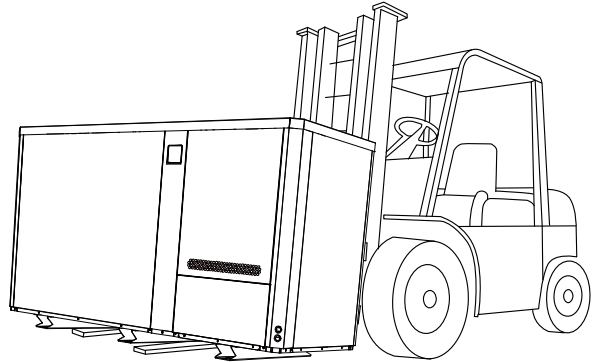

2. INSTALLATION AND MAINTENANCE

⚠ The heat pump must be installed by a professional team. The users are not qualified to install by themselves, otherwise the heat pump might be damaged and risky for users' safety.

2.1. Notice before installation:

2.1.1. The inlet and outlet water unions **can't** bear the weight of soft pipes. The heat pump must be connected with hard pipes!

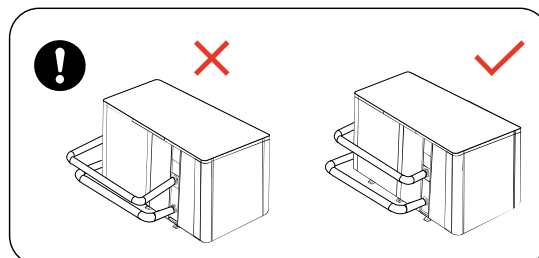

2.1.2. In order to guarantee the heating efficiency, the water pipe length should be $\leq 10\text{m}$ between the pool and the heat pump.

2.2. Installation instruction

2.2.1. Location and size

⚠ The heat pump should be installed in a place with good ventilation

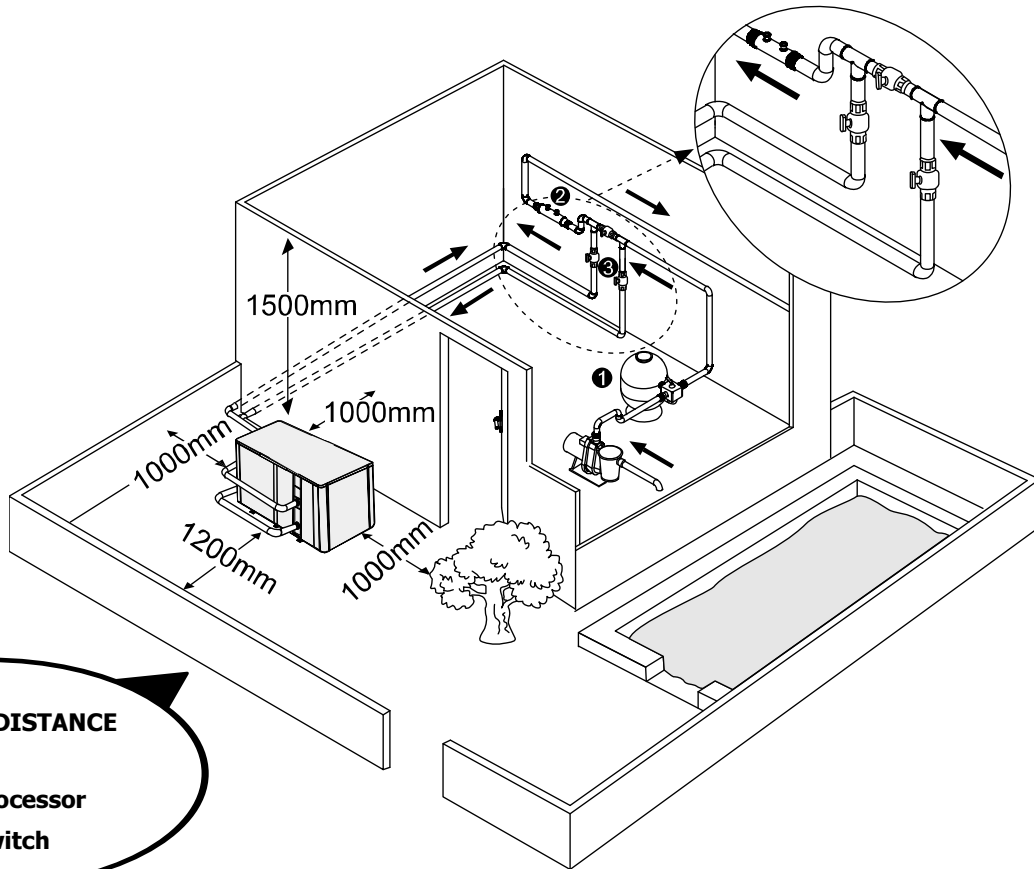

*** MINIMUM DISTANCE**

- ① Filter
- ② Water processor
- ③ Water switch

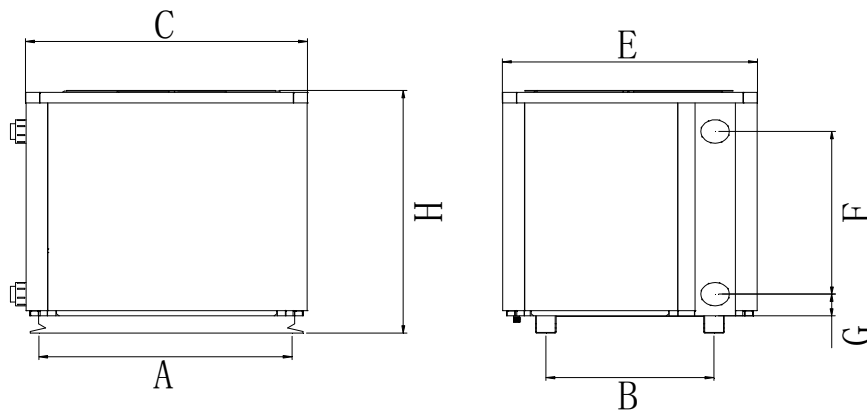

	UNIT=MM	A	B	C	D	E	F	G	H
Model	7300720	1000	660	1110	1070	1000	780	105	1260

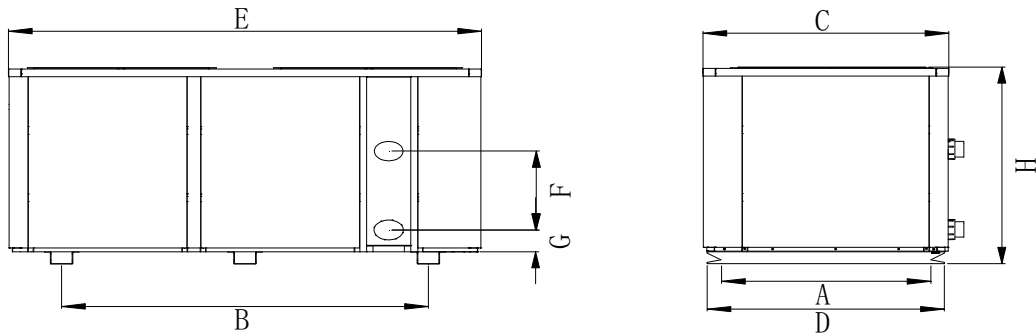

	UNIT=MM	A	B	C	D	E	F	G	H
Model	7300721	1000	1630	1090	1050	2100	515	140	1280

※ *Above data is subject to modification without notice.*

2.2.2. Heat pump installation.

- The frame must be fixed by bolts (**M10**) to concrete foundation or brackets. The concrete foundation must be solid; the bracket must be strong enough and anti-rust treated;
- The heat pump needs a water pump (**Supplied by the user**). The recommended pump specification-flux: refer to Technical Parameter, Max. lift **≥10m**;

2.2.3. Wiring & protecting devices and cable specification

- Connect to appropriate power supply, the voltage should comply with the rated voltage of the products.
- Well earth the heat pump.
- Wiring must be connected by a professional technician according to the circuit diagram.
- Set breaker or fuse according to the local code (leakage operating current $\leq 30\text{mA}$).
- The layout of power cable and signal cable should be orderly and not affecting each other.

⚠ 1. How to connect to the terminal board

Step 1. open the maintenance panel

① Remove three screws outside

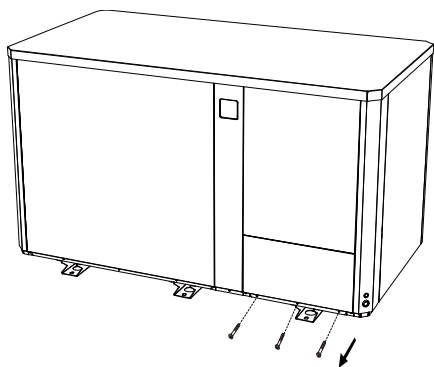

② Open the panel

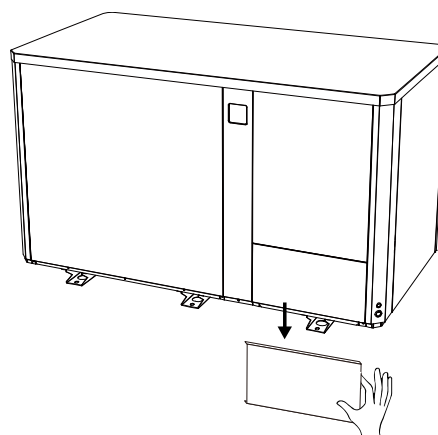

③ Remove two screws inside

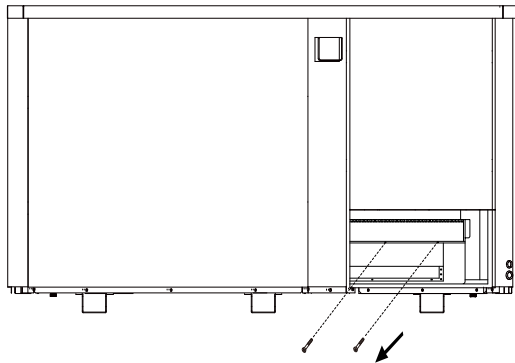

④ Open the internal

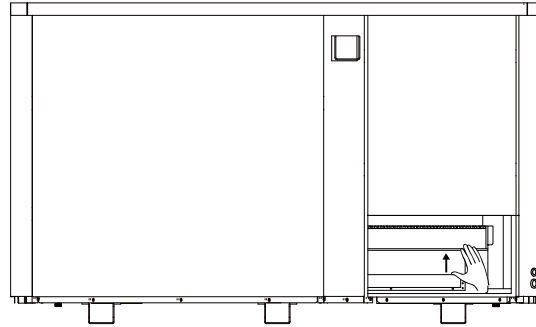

Step 2. Power cord must be passed through below 3 holes

① Connect the wire through three holes

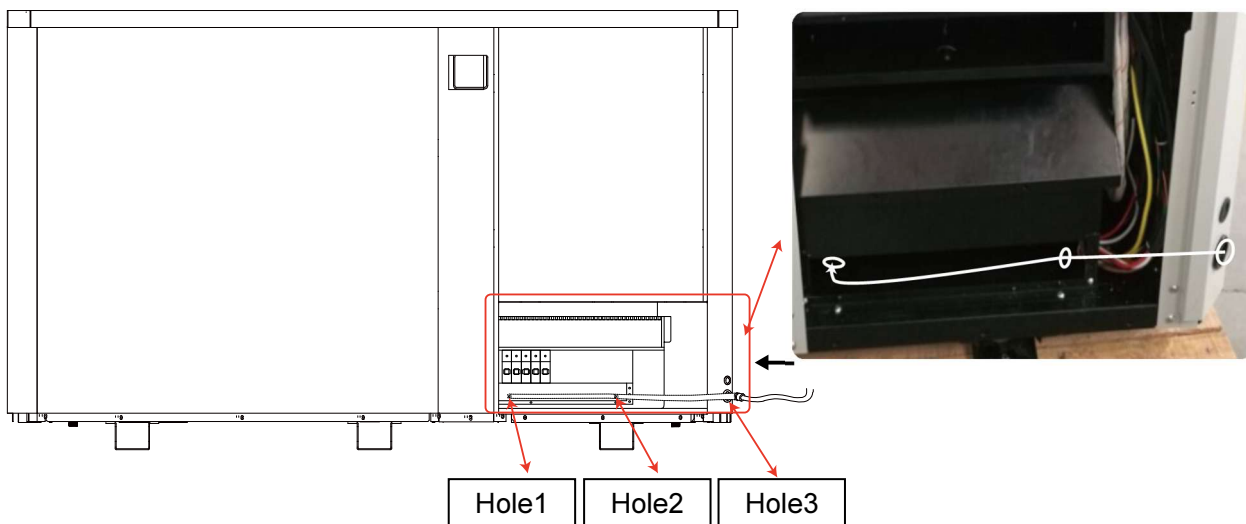

② Restore the internal panel

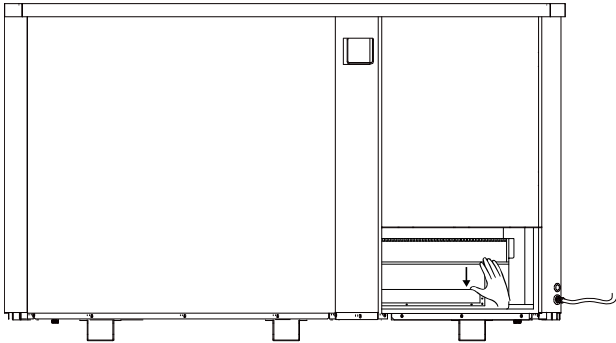

③ Fix the internal panel by two screws

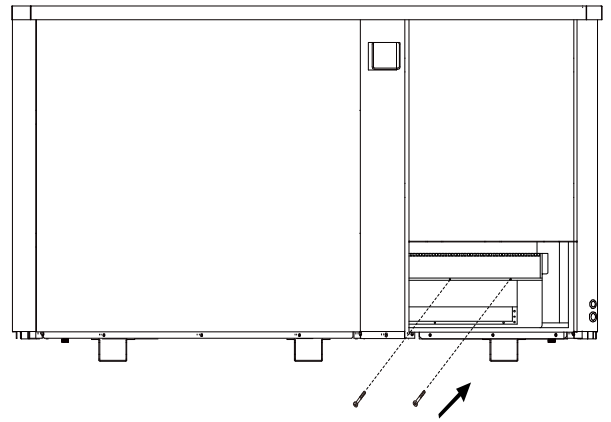

④ Restore the panel

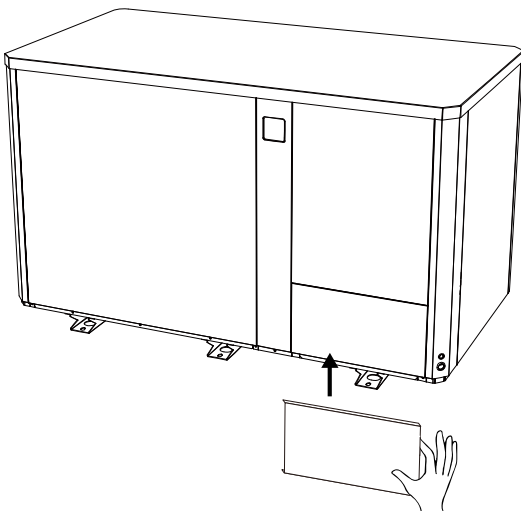

⑤ Fix the panel by three screws

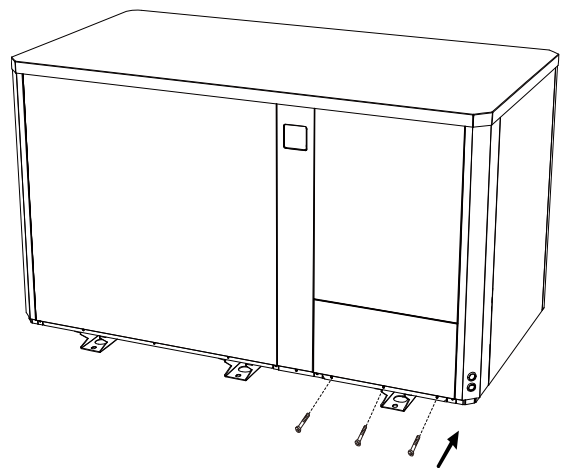

⚠ 2. Wiring diagram

For power supply: 400V 50Hz

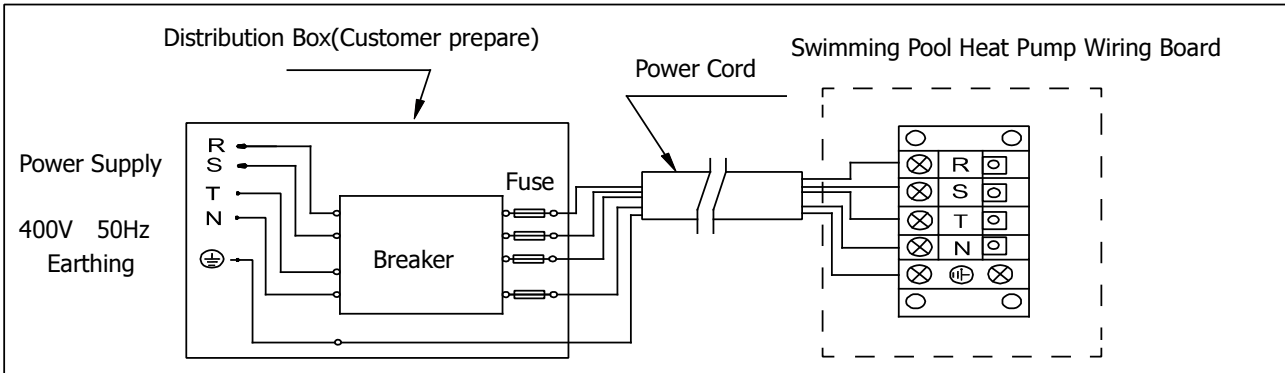

NOTE:

⚠ Must be hard wired, no plug allowed

- For your safe use in winter, it's strongly recommended to equip heating priority function.
- For the detailed wiring diagram, please refer to Appendix 1.

3. Options for protecting devices and cable specification

MODEL		7300720	7300721
Breaker	Rated Current A	23	45
	Rated Residual Action Current mA	30	30
Fuse A		23	45
Power Cord (mm ²)		5×6	5×16
Signal cable (mm ²)		3×0.5	3×0.5

NOTE: The above data is adapted to power cord ≤ 10m. If power cord is >10m, wire diameter must be increased. The signal cable can be extended to 50m at most.

2.3. Trial after installation

⚠ Please check all the wirings carefully before turning on the heat pump.

2.3.1. Inspection before use

- Check installation of the whole heat pump and the pipe connections according to the pipe connecting drawing;
- Check the electric wiring according to the electrical wiring diagram and earthing connection;
- Make sure that the main power is well connected;
- Check if there is any obstacle in front of the air inlet and outlet of the heat pump

2.3.2. Trial

- The user is advised to start the water pump before the heat pump, and turn off the heat pump before the water pump for long life circle.
- The user should start the water pump, and check for any leakage of water; Power on and press the ON/OFF button of the heat pump, and set desired temperature in the thermostat.
- In order to protect the heat pump, the heat pump is equipped with start delay function. When starting the heat pump, the fan will start to run in 3 minutes, in another 30 seconds, the compressor will start to run.
- After pool heat pump starts up, check for any abnormal noise from the heat pump.
- Check the temperature setting.

2.4. Maintenance and winterizing

2.4.1 Maintenance

⚠ The maintenance should be carried out once per year by qualified professional technician.

- Cut off power supply of the heat pump before cleaning, examination and repairing .
Do not touch the electronic components until the LED indication lights on PCB turn off.

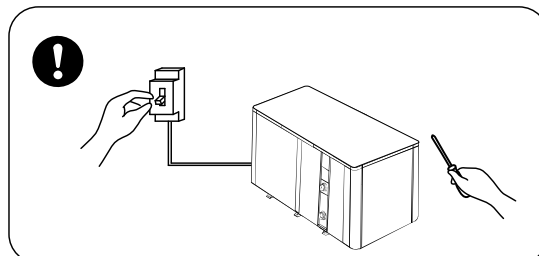

- Please clean the evaporator with household detergents or clean water, NEVER use gasoline,

thinners or any similar fuel.

- Check bolts, cables and connections regularly.

2.4.2 Winterizing

In winter season when you don't swim, please cut off power supply and drain water out of the heat pump. When using the heat pump under 2°C, make sure there is always water flow.

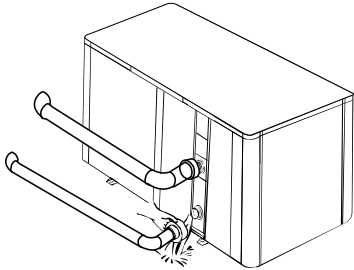

⚠ Important:

Unscrew the water union of inlet pipe to let the water flow out.

When the water in machine freezes in winter season, the titanium heat exchanger may be damaged.

3. TROUBLE SHOOTING FOR COMMON FAULTS

FAILURE	REASON	SOLUTION
Heat pump doesn't run	No power	Wait until the power recovers
	Power switch is off	Switch on the power
	Fuse burned	Check and change the fuse
	The breaker is off	Check and turn on the breaker
Fan running but with insufficient heating	evaporator blocked	Remove the obstacles
	Air outlet blocked	Remove the obstacles
	3 minutes start delay	Wait patiently

FOR INSTALLERS AND PROFESSIONALS

Display normal, but no heating	Set temp. too low	Set proper heating temp.
	3 minutes start delay	Wait patiently
If above solutions don't work, please contact your installer with detailed information and your model number. Don't try to repair it yourself.		

ATTENTION! Please don't try to repair the heat pump by yourself to avoid any risk.

4. Failure code

NO.	Display	Not failure description
1	E3	No water protection

FOR INSTALLERS AND PROFESSIONALS

2	E5	Power supply exceeds operation range
3	E6	Excessive temp difference between inlet and outlet water(Insufficient water flow protection)
4	Eb	Ambient temperature too high or too low protection
5	Ed	Anti-freezing reminder
NO.	Display	Failure description
1	E1	High pressure protection
2	E2	Low pressure protection
3	E4	3 phase sequence protection (three phase only)
4	E7	Water outlet temp too high or too low protection
5	E8	High exhaust temp protection
6	EA	Evaporator overheat protection (only at cooling mode)
7	EC	System communication failure
8	P0	Controller communication failure
9	P1	Water inlet temp sensor failure
10	P2	Water outlet temp sensor failure
11	P3	Gas exhaust temp sensor failure
12	P4	Evaporator coil pipe temp sensor failure
13	P5	Gas return temp sensor failure
14	P6	Cooling coil pipe temp sensor failure
15	P7	Ambient temp sensor failure
16	P8	Cooling plate sensor failure
17	P9	Current sensor failure
18	PA	Restart memory failure
19	F1	Compressor drive module failure
20	F2	PFC module failure
21	F3	Compressor start failure
22	F4	Compressor running failure
23	F5	Inverter board overcurrent protection
24	F6	Inverter board overheat protection
25	F7	Current protection
26	F8	Cooling plate overheat protection
27	F9	Fan motor failure
28	Fb	Power filter plate No-power protection
29	FA	PFC module overcurrent protection
30	FC	AC fan motor overcurrent protection
31	Fd	AC fan motor overheat protection
32	FE	AC fan motor phase protection

APPENDIX 1: HEATING PRIORITY WIRING DIAGRAM (OPTIONAL)

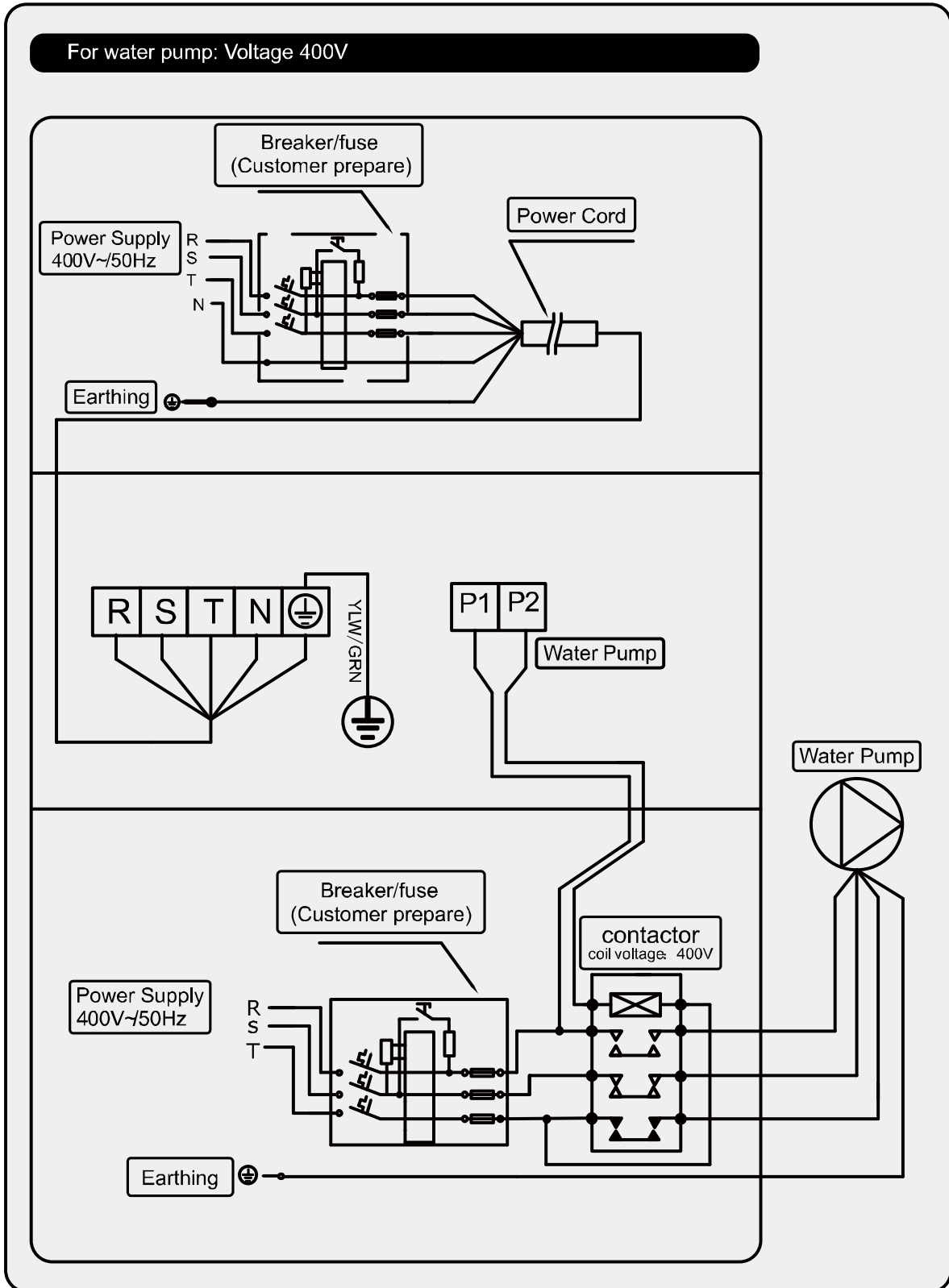

Parallel connection with filtration clock

A: Water pump timer

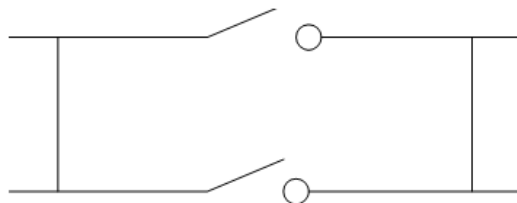

B: Water pump wiring of Heat Pump

Note: The installer should connect A parallel with B (as above picture). To start the water pump, condition A or B is connected. To stop the water pump, both A and B should be disconnected

5. WIFI SETTING

1) APP Download

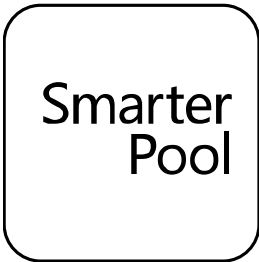

Android mobile please download from

iphone please download from

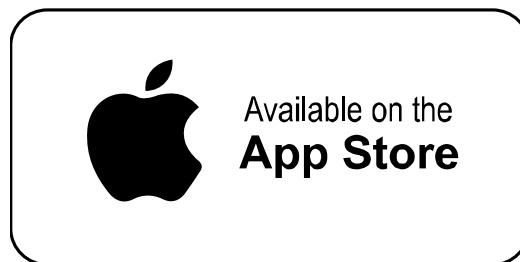

2) Account registration

a) Registration by Cell phone number/Email

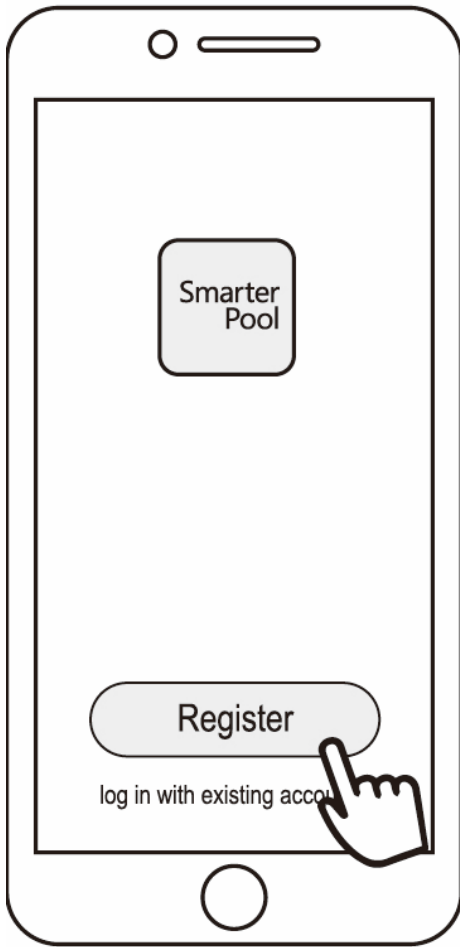

b) Cell phone number registration

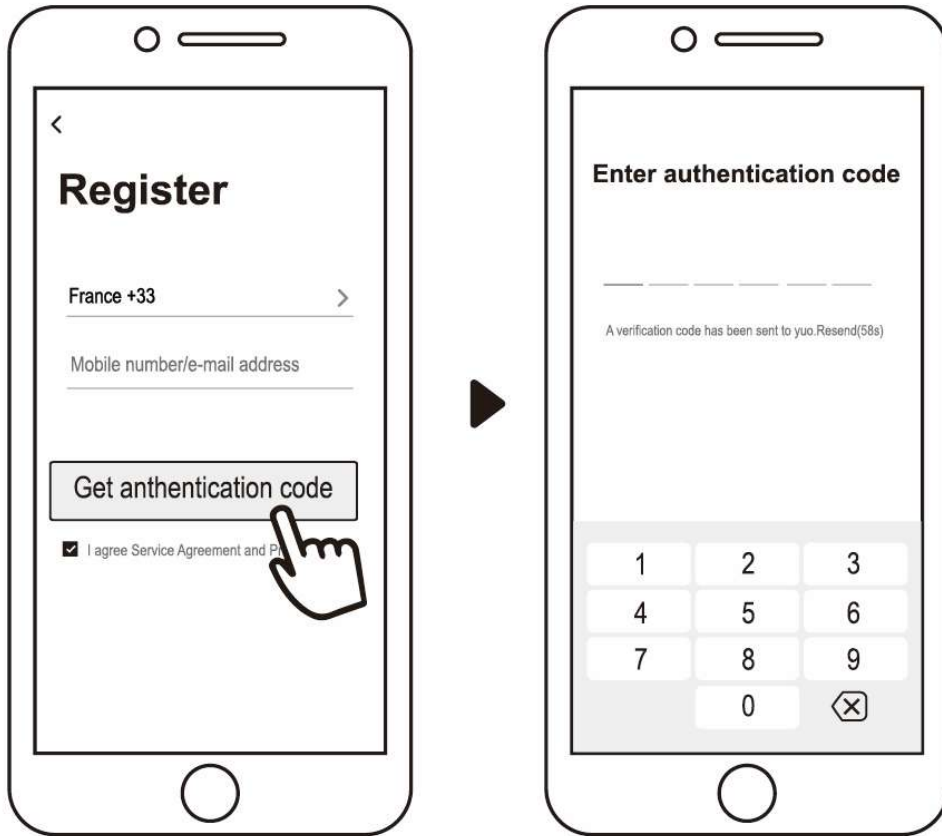

3) Create family



Please set family name and choose the room of device





4) APP Binding

Please make sure your cell phone has connected the Wifi

a) Wifi connection:

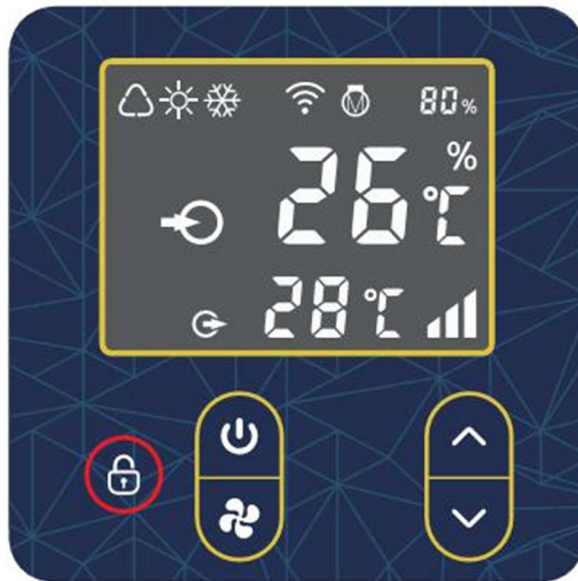
Press  for 3 seconds after screen unlock,  will be flashing to enter Wifi binding program.



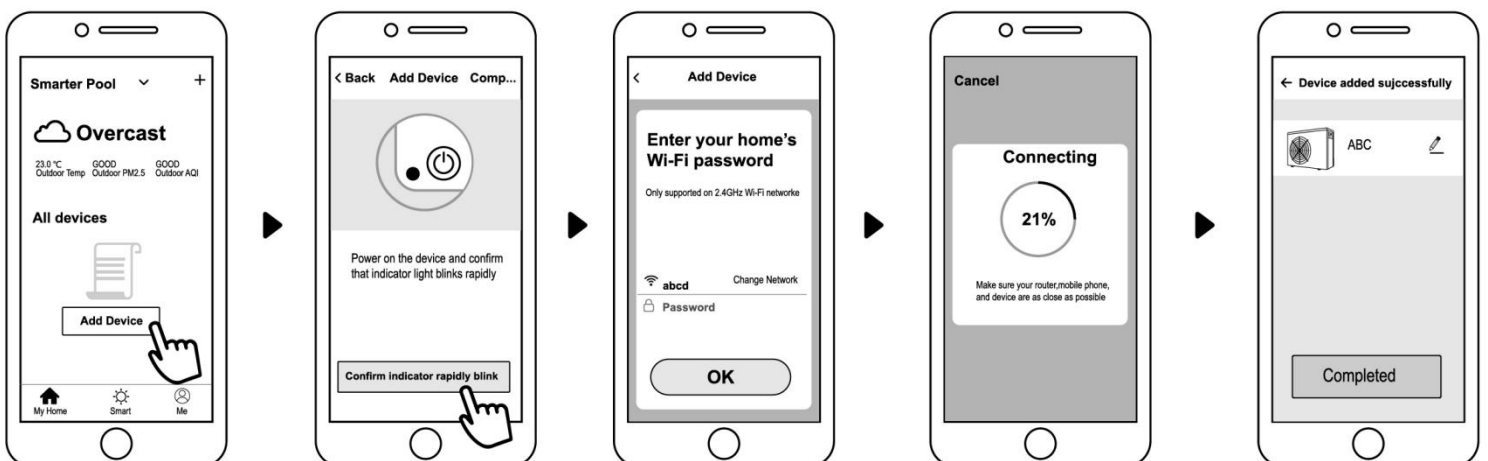

b) Click "Add device", follow indication to finish binding.  display on the screen once Wifi connection success.



c) If connect fails, please make sure your network name and password is correct. And your router, mobile phone and device are as close as possible.

d) Wifi rebinding (When Wifi password changes or network configuration changes):

Press  for 10 seconds,  will be flashing slowly for 60 seconds. Then  will be off. The original binding will be removed. Follow step above for rebinding.

Remarks: Please make sure the router is configured at 2.4G.

5) Operation

For heat pump with Heating function only.

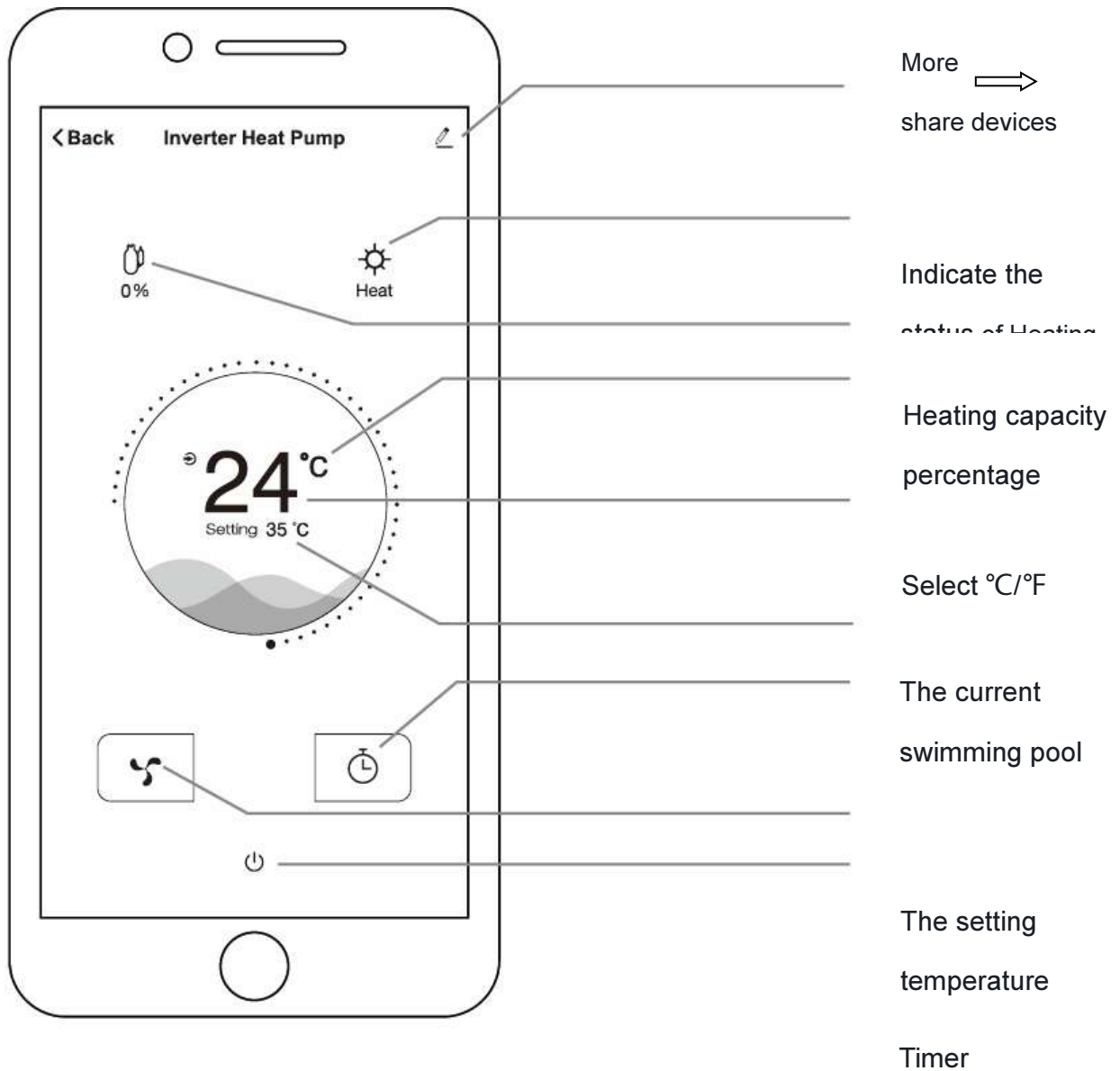

Select Smart/

Silence Mode

On/Off

6) Share devices to your family members

After binding, if your family members also want to control the device.

Please let your family members register the APP first, and then the administrator can operate as below:

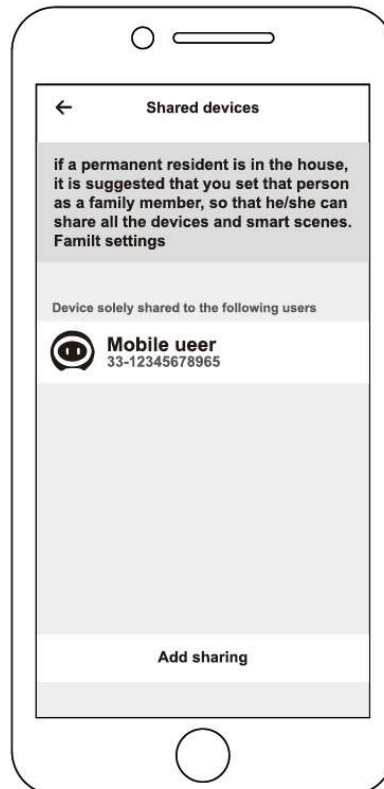
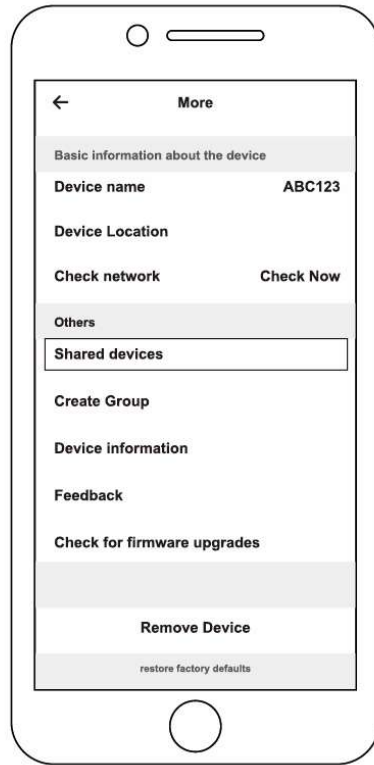
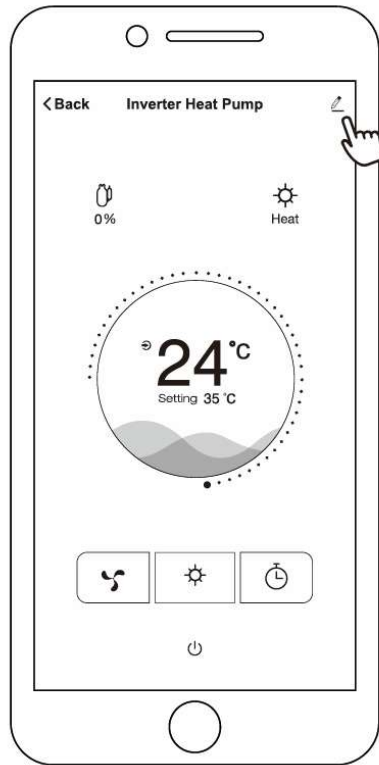

Then your family members can log in as below:

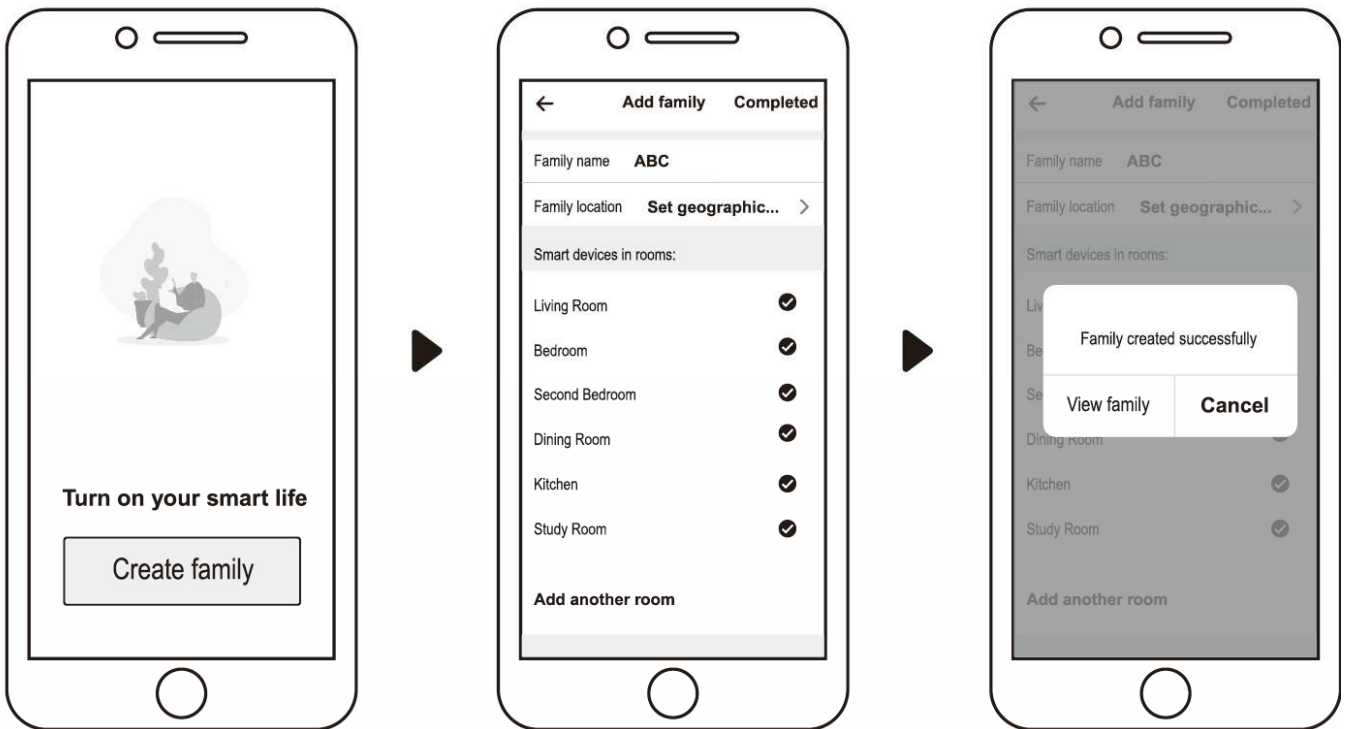

Notice: 1. The weather forecast is just for reference.

2. APP is subject to updating without notice.

Thank you for choosing Full-inverter pool heat pump

