

LOXONE BUS (CAN) → LOX\_LINK- / 3.5  
 LOXONE BUS (CAN) → LOX\_LINK+ / 3.5  
 LOXONE VER. → LOX\_OV / 2.0

Versorgung  
230V+N+PE/50-60HZ

-A21  
Aquastar  
LOXONE

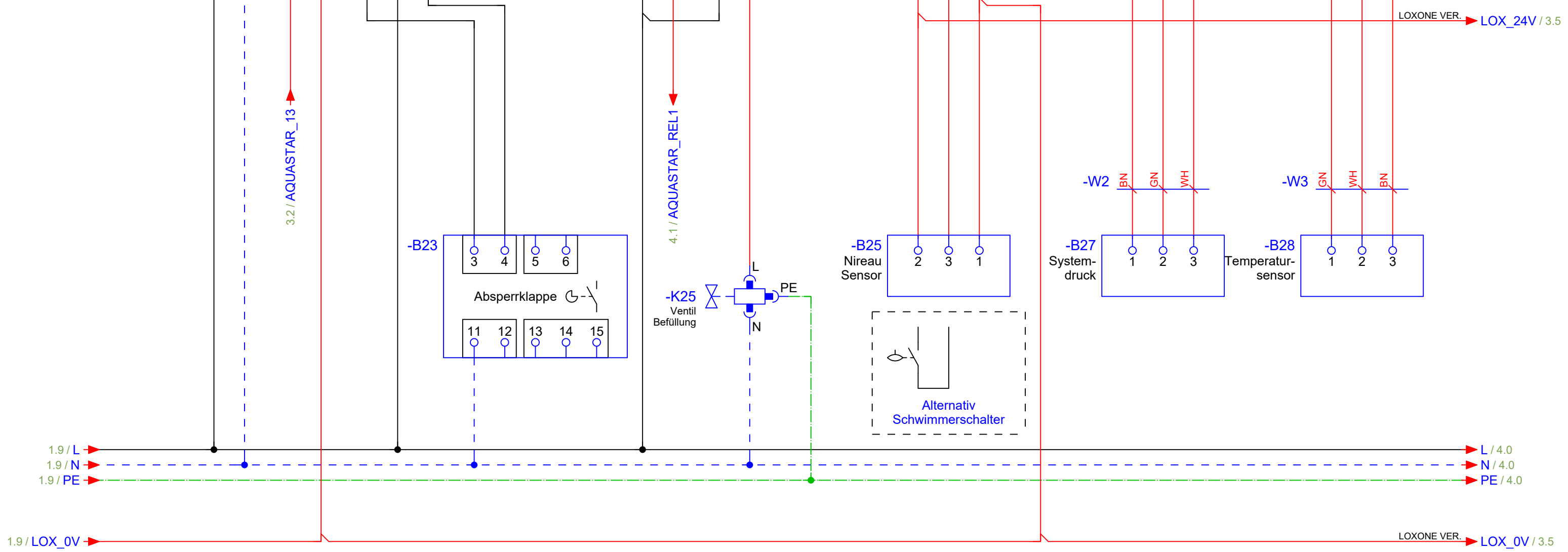

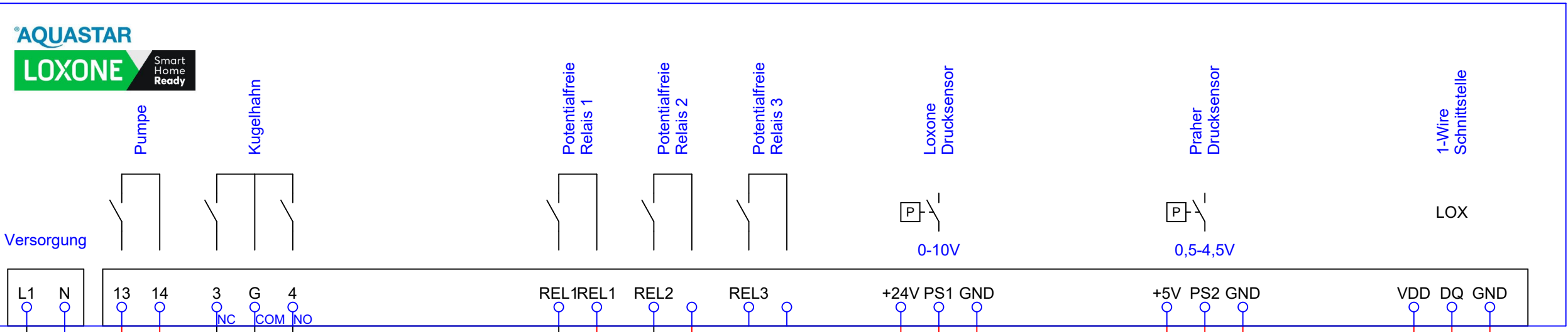
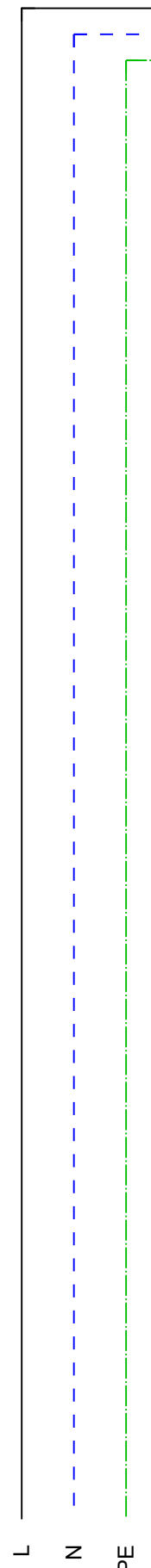

-A31  
Filterpumpe  
E. PRO

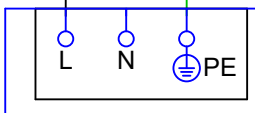

-W4

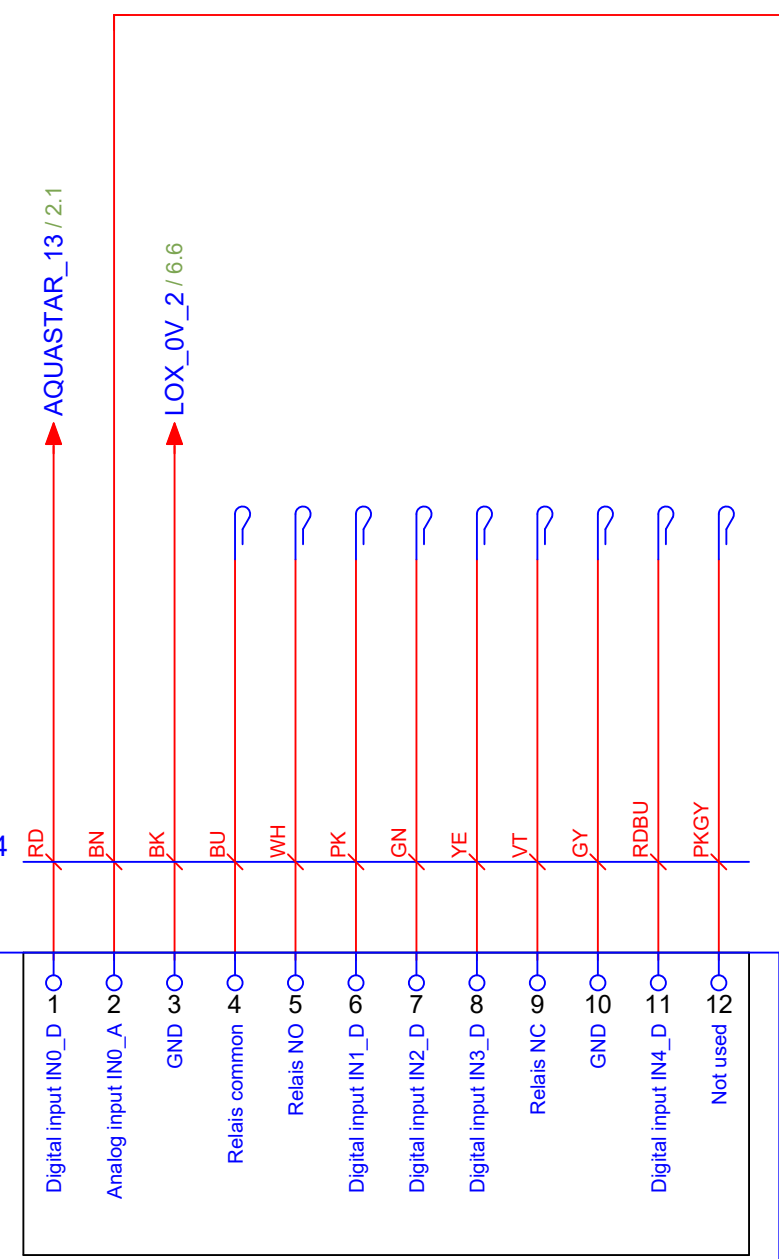

AQUASTAR\_13 / 2.1

LOX\_0V\_2 / 6.6

-A36  
AO  
Extension

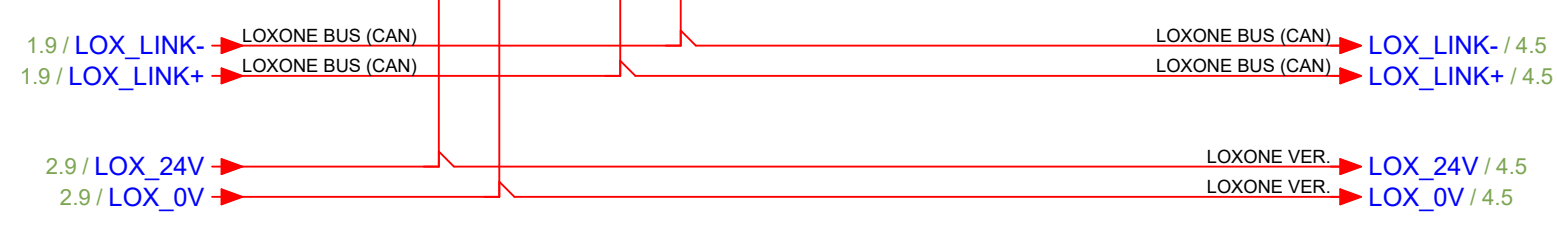
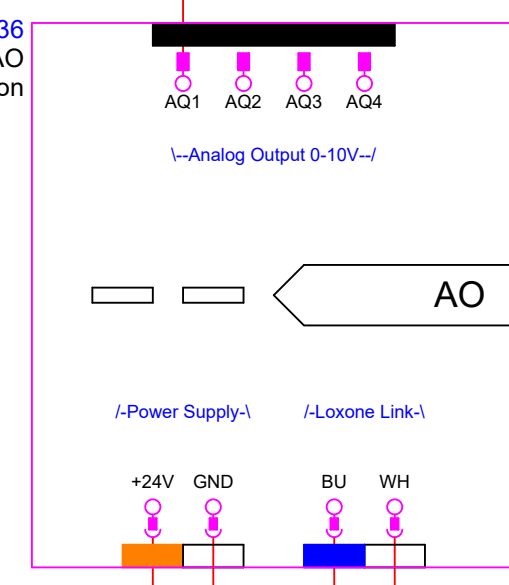

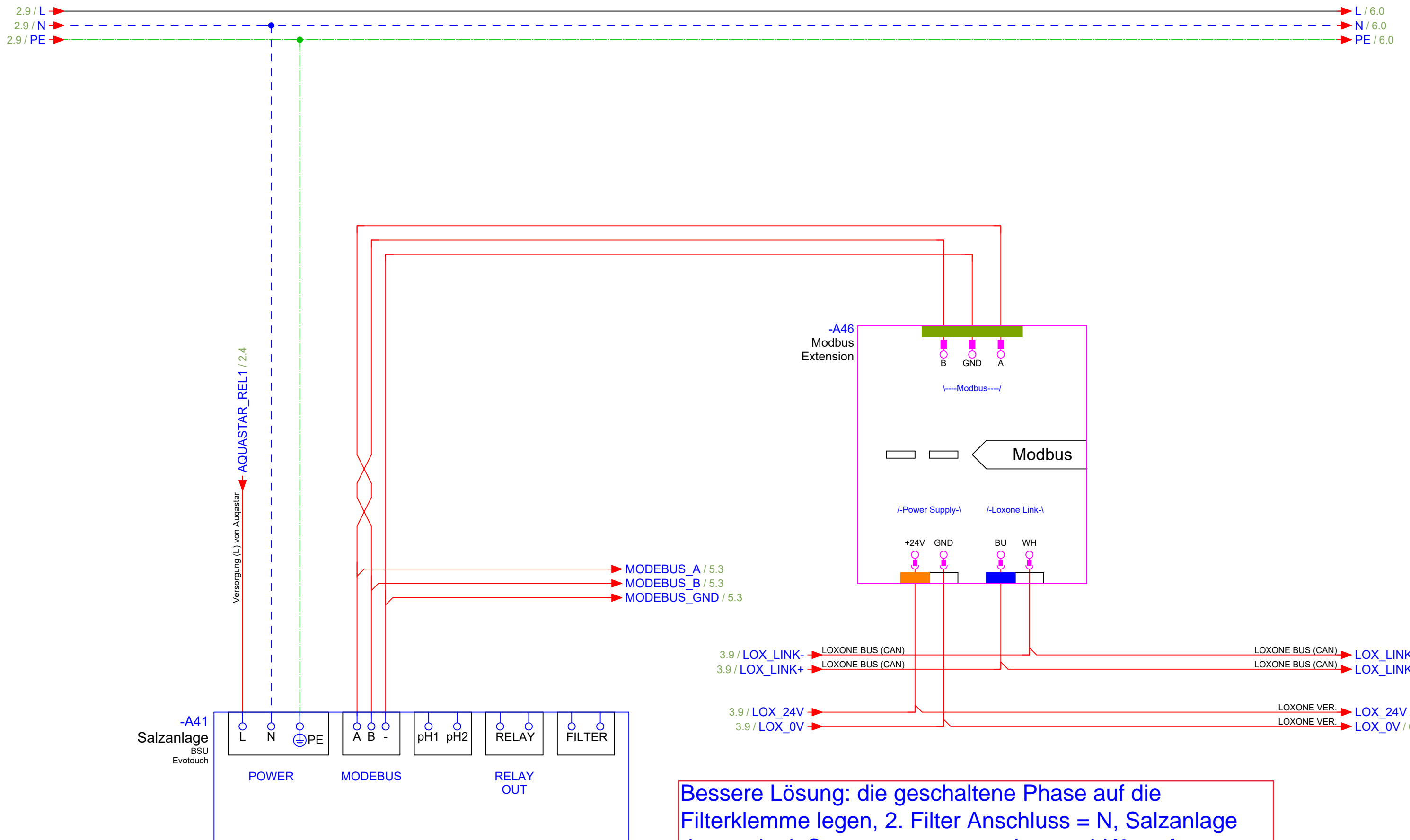

Bessere Lösung: die geschaltene Phase auf die Filterklemme legen, 2. Filter Anschluss = N, Salzanlage dauernd mit Strom versorgen -> Jumper LK2 entfernen, dadurch wird die Start-Stopp Steuerung aktiv. D.h. Freigabe nur, wenn an Filterklemmen 230V anliegen

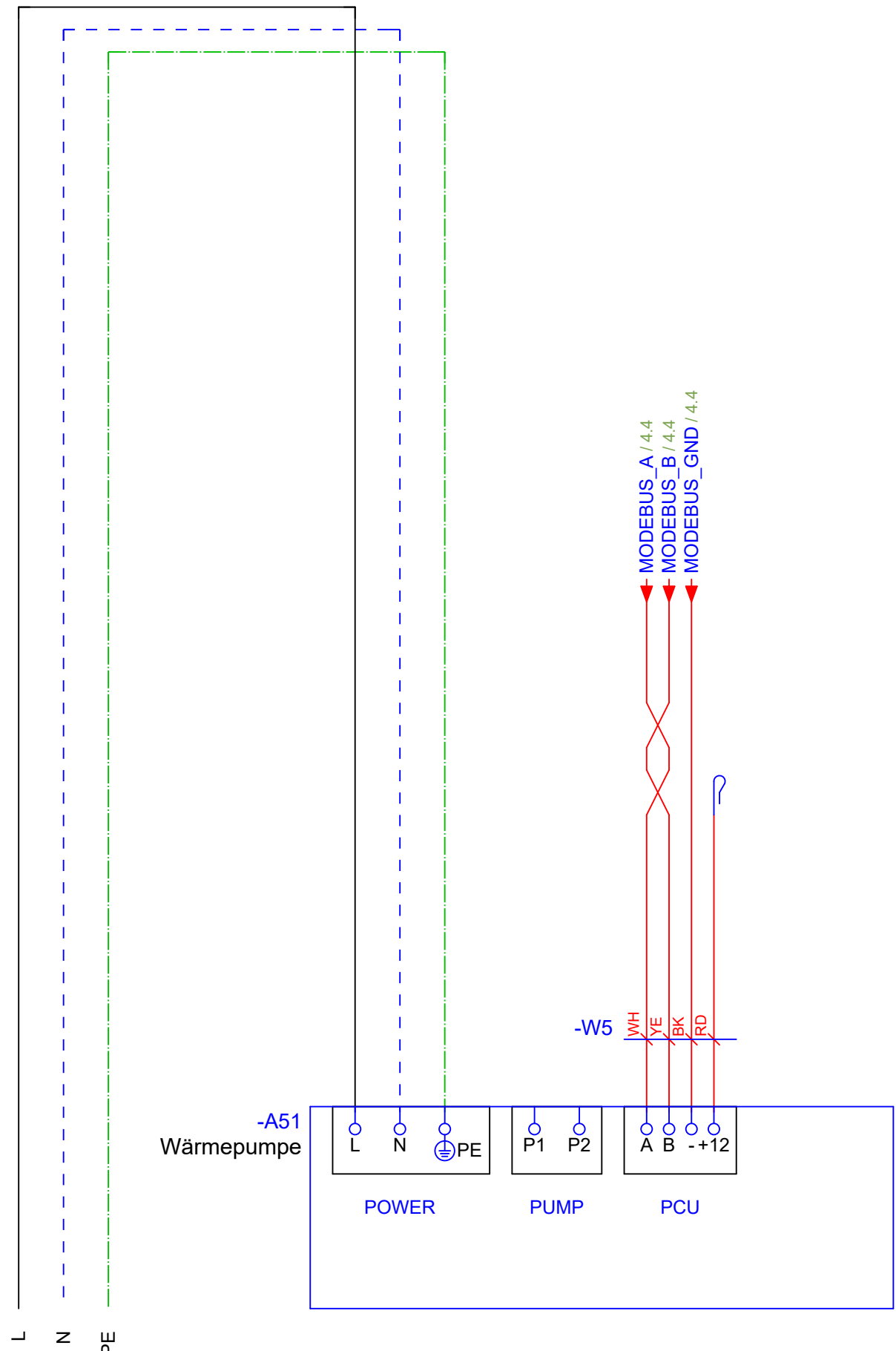

Versorgung  
lt. Typenschild

230V+N+PE/50-60HZ

