

USER GUIDE



ondilo.com

ICO Introduction



ICO, YOUR CONNECTED DEVICE TO YOUR POOL, MEASURE, ANTICIPATE, FORMULATE RECOMMENDATIONS AND NOTIFY YOU ON YOUR SMARTPHONE

Simply drop ICO in the pool and check via smartphone the water quality. ICO's multiple sensors keep an eye on the pool, evaluating visible elements (e.g. algae, lime scale) and invisible ones (e.g. bacteria, aggressive water). ICO formulates recommendations to optimise the use of chemicals (e.g. type, dosing). Keeping the water chemistry balance right to making savings in chemicals and protecting your pool surface and equipment.

ICO measures

ICO takes a complete set of measures:

- Temperature
- pH
- ORP

- Conductivity
- Battery level
- Wi-Fi level

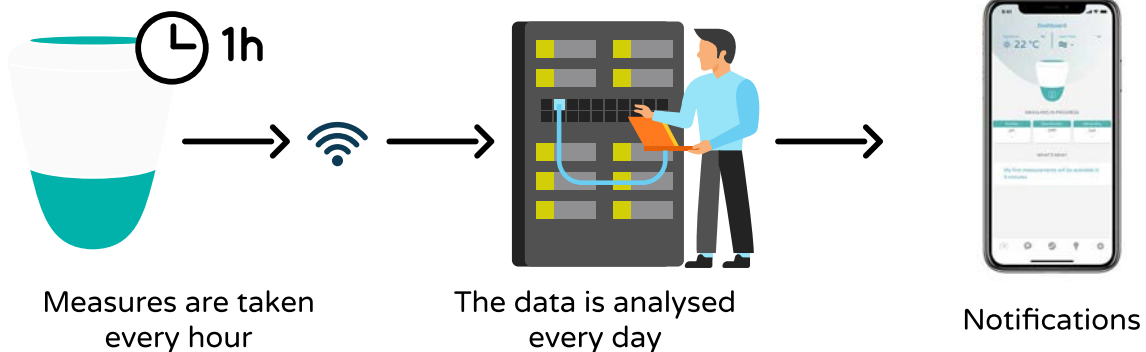

When you switch your ICO ON, it makes its first measure:

- Every 10 min, during the first hour
- These measures are relayed by the wireless connection to the server; which analyses them

After the first hour, ICO takes a normal rhythm; with a measure every hour.

THE ICO APPLICATION

- Recommendations to optimise the use of chemicals (e.g. type, dosing);
- Trends & variations over time;
- A real understanding of your pool water quality;
- Anticipates the variations of your pool water quality and notifies you on time.

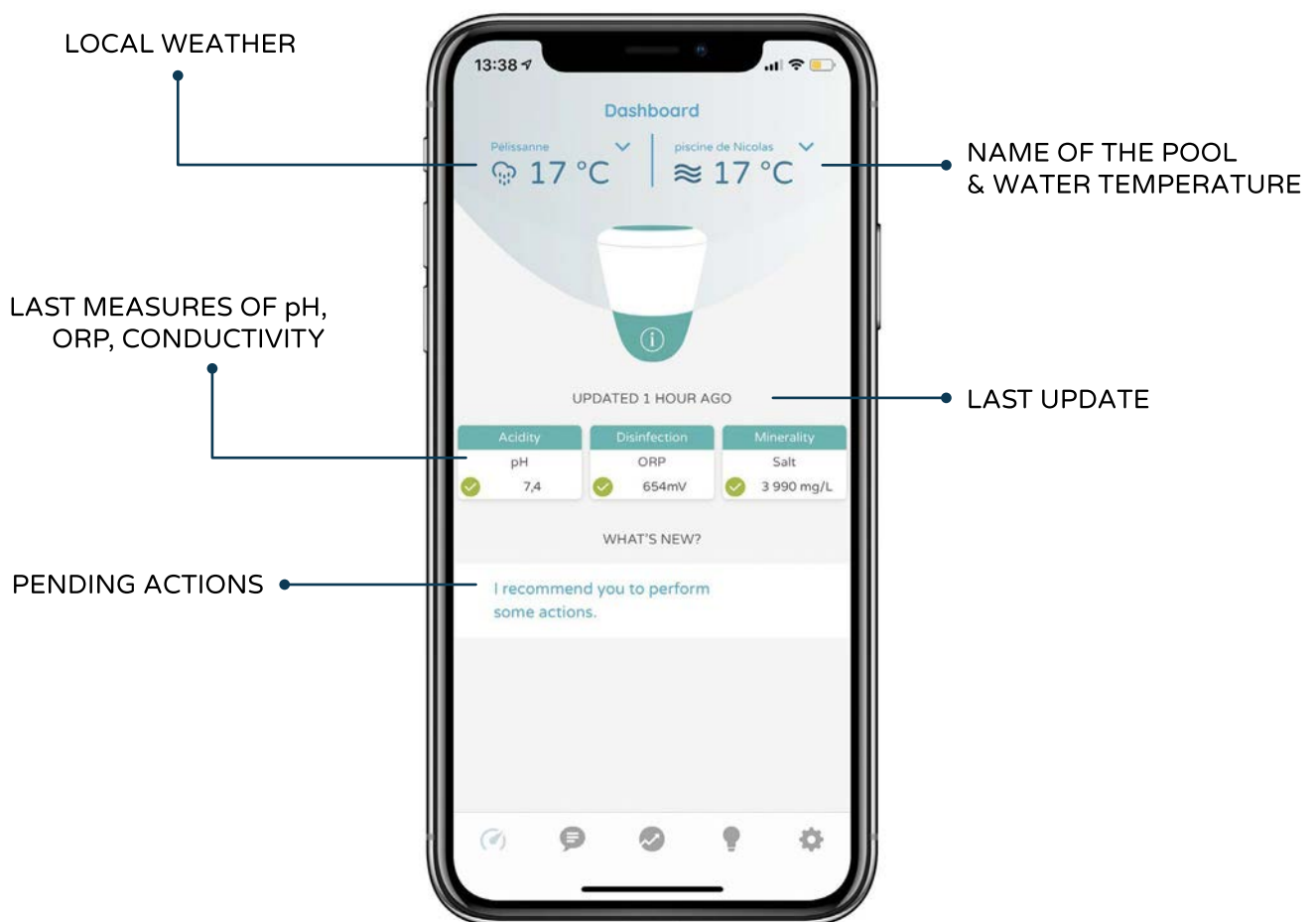

CONTENTS

ICO Introduction	p.2
Application set up	p.5
Create your account	p.6
Create your pool	p.6
Identify your ICO	p.7
Initial configuration	p.8
Maintenance	p.12
Usage precautions	p.15
Warranty	p.16
Technical features	p.18
Trouble shooting	p.21



APPLICATION SET UP

Before switching your ICO ON, download the application



Follow the instructions,
step by step on the application.

CREATE YOUR ACCOUNT

Follow the application instructions

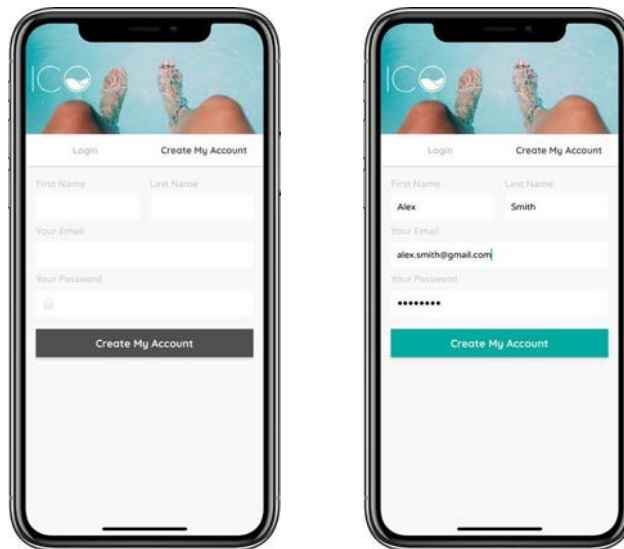

CREATE YOUR POOL

Follow the application instructions

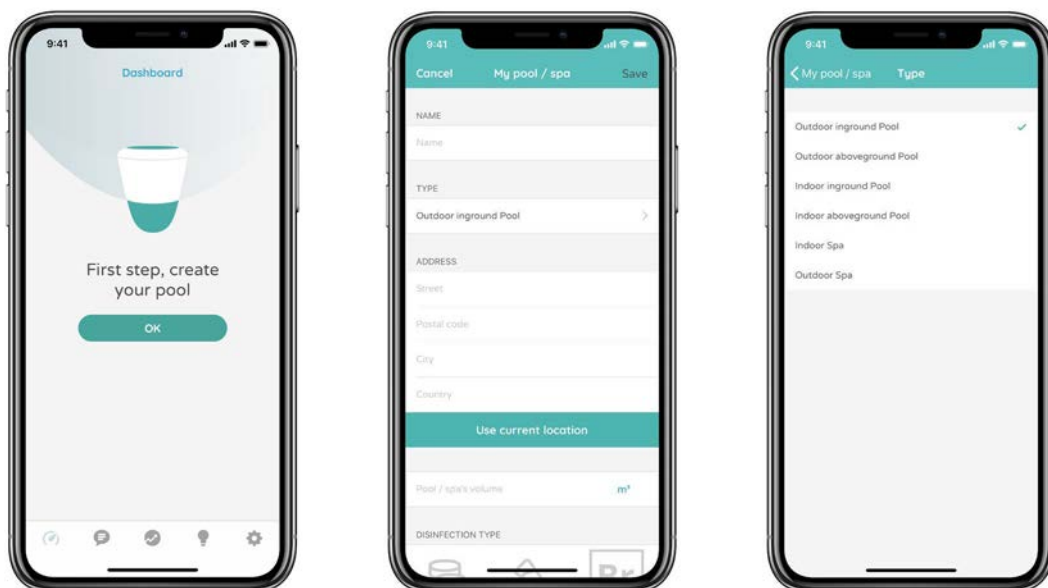

IDENTIFY YOUR ICO

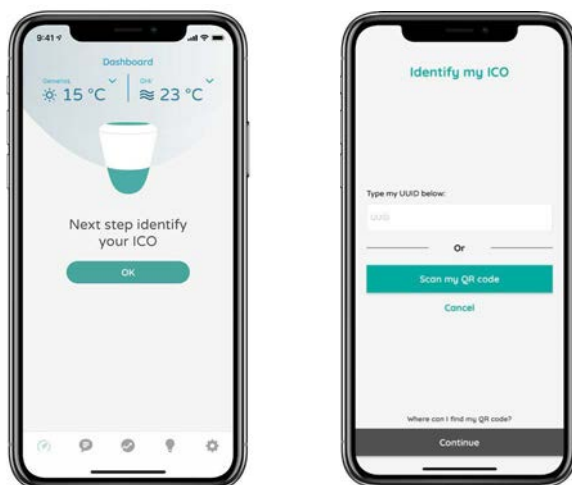

Your QR code is in the upper lid of your ICO packaging.



Please don't throw away the packaging, it will be needed to maintain your ICO in a safe place when out of the water.

INITIAL CONFIGURATION

Follow the application instructions

Configure your ICO



Open your ICO

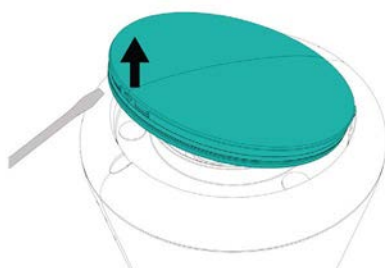

Using the opening tool, remove the upper cap.

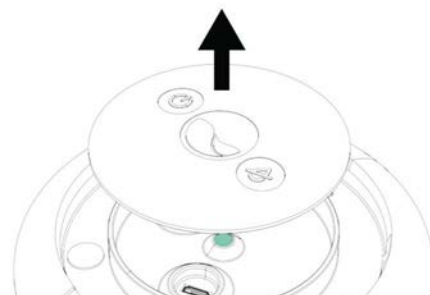

Remove the upper-sensitive cap

Be careful !

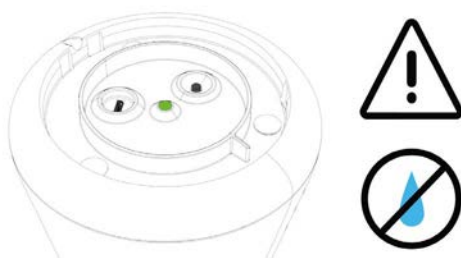

Sensitive area!
Ensure no drops of water enter inside your ICO.

INITIAL CONFIGURATION

Switch your ICO ON

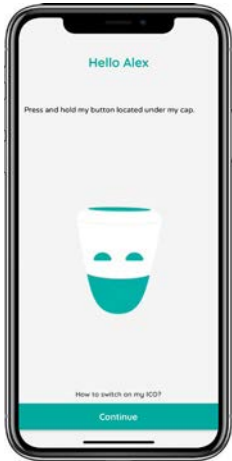

Push !   5 sec.

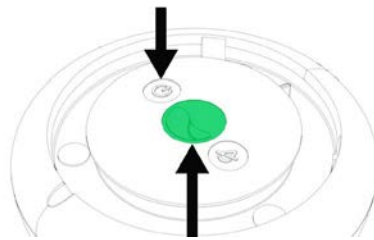

ICO ON



ICO ON

You can also remove the inside protection lid and press the button on.

Close your ICO

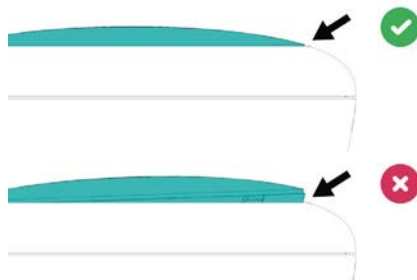

Ensure the upper cap is firmly in place to waterproof ICO before placing it in the water.

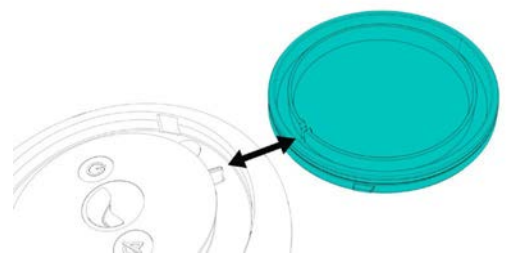

When placing the upper cap on ICO, align the notches with the pins.

INITIAL CONFIGURATION

Put your ICO into the water

Turn left to remove the sensors protection cap.
Take the sensor caps off and keep them in the original box,
it will be useful for the wintering of ICO.

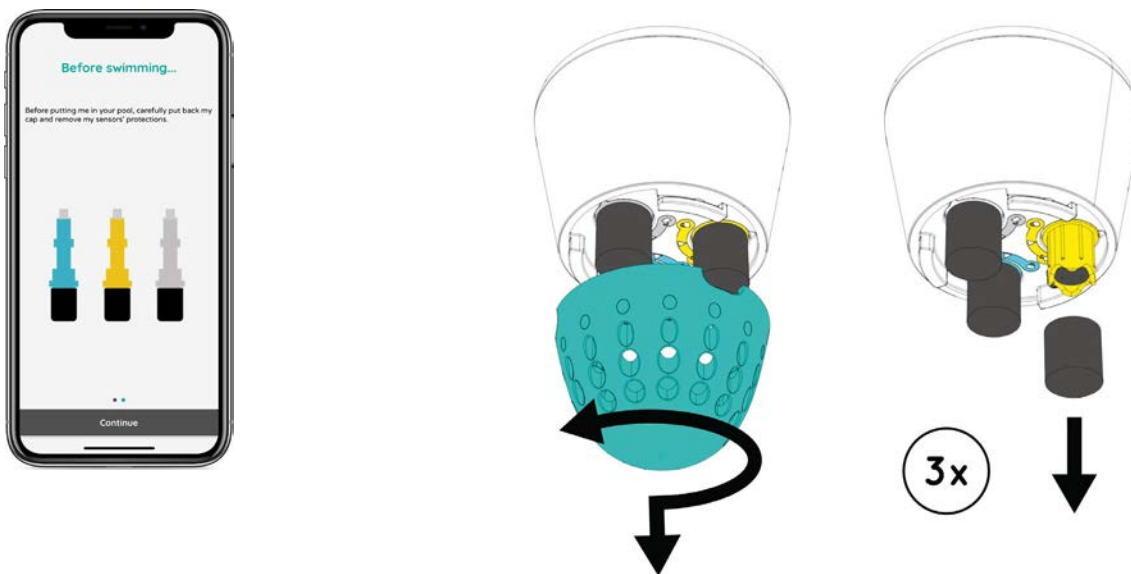

Screw back the protection cap before placing lco into the water.

Before the initial configuration

Follow the application instructions

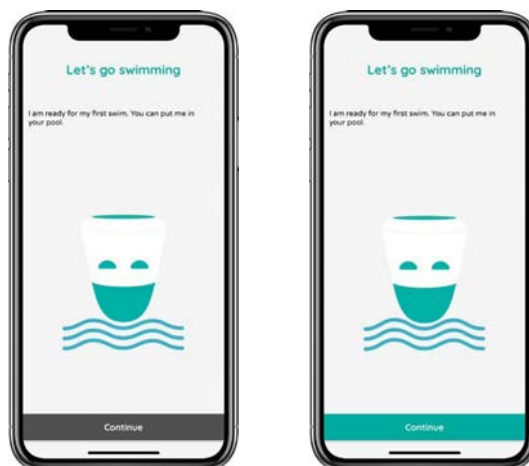

INITIAL CONFIGURATION

Connecting ICO to the internet

Follow the application instructions

Configure manually or with current network

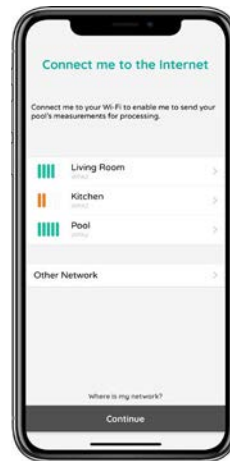

Repeater configuration

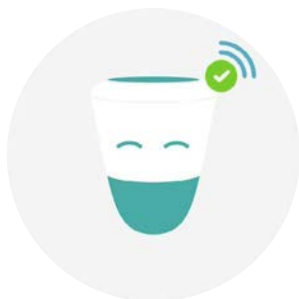
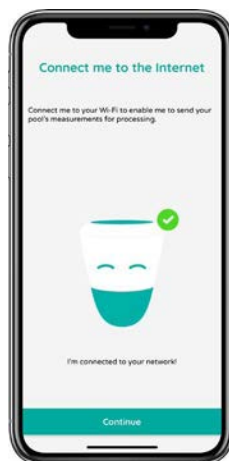

Congratulations ! Your ICO has been connected with success, it's time to start measurements and enjoy your pool.

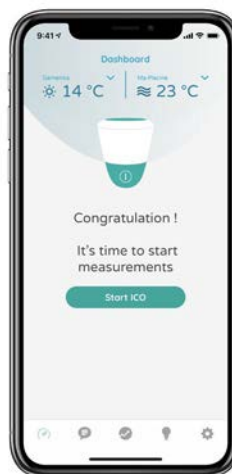

MAINTENANCE

Switch your ICO OFF

Before beginning the maintenance, please turn ICO off.



Press the button for a minimum of 5 seconds until you see the yellow LED flickering.

Sensor replacement

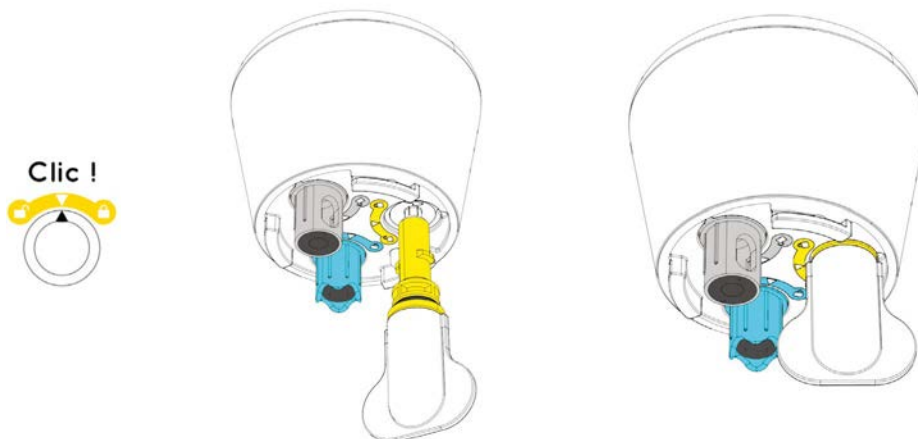

Technical specifications

The ICO sensors are patented and overmoulded.
The Twist&Lock system eases their replacement.

- The blue sensor measures the pH.
- The orange sensor measures the ORP (Redox).
- The grey sensor measures the water conductivity.

Sensor maintenance

It is recommended to clean the 3 sensors (orange, grey, blue) once a month.

Remove ICO out of the water, take the protection hood off and clean the sensors with a damp and non-abrasive cloth. Place the protection hood back on ICO and simply drop ICO back into the pool.

Charge your ICO

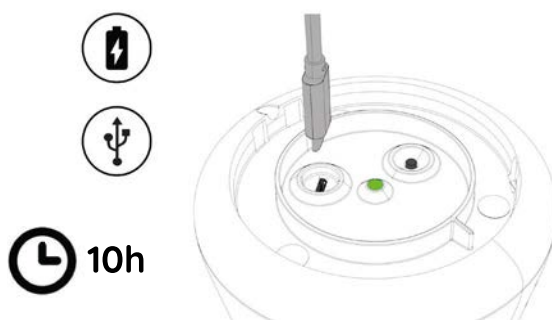

Long-life battery
USB cable and charger supplied.
Charge your ICO for a minimum of 10h

The LED indicator

The LED indicator situated under ICO's cap will give you ICO's status.

Press 5 seconds:

- My ICO flickers green 3 times: ICO is switching ON.
- My ICO flickers yellow once: ICO is switching OFF.

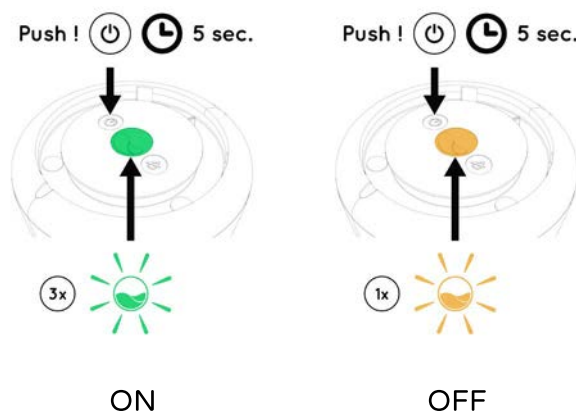

Briefly press:

- My ICO flickers green twice: ICO is switched ON.
- My ICO flickers yellow twice: the battery is low.
- ⊗ My ICO doesn't flicker: ICO is switched OFF.

Store/Winterize your ICO

Follow the steps :

- Remove ICO from the pool.
- Dry ICO thoroughly.
- Switch ICO OFF (cf page11).
- Dampen the 2 sponges for the blue & the orange sensors.
- Place the 2 sponges inside the protective caps.
- Put the protective caps on the 3 sensors (grey, orange & blue).
- Activate your winterize feature of your ICO application.
- Place ICO back in its original box.

USAGE INSTRUCTIONS

ICO LOCATION

ICO is a product that must be placed and used only in a swimming pool. ICO does not measure any data when it is out of the water.

Do not place ICO near an extreme heat or cold source. In the case of a water outlet, it is imperative to protect the sensors with their protective caps by previously moistening small sponges inside them. If you decide to take ICO out of the water for an extended period of time, it is strongly recommended to place it in its protected box with its humidified protective caps, protected from dust. You will be able to leave it in the best possible conditions at the beginning of the next season.

The use of ICO does not present a risk of electrocution.

INSTALLATION AND USE OF ICO

Make sure ICO and the colored analysis chamber are not covered or hindered by any obstruction such as leaves, buoys, etc. This can alter the measurements or stop data emission.

ICO does not present any risk for the swimmers, it is especially designed to float on the pool surface on a permanent basis. ICO should not be used as a toy. It is recommended to keep ICO out of reach from children under the age of six.

For safety reasons, and in compliance with the warranty terms, it is imperative to use the USB cable and the accessories supplied with ICO. The company Ondilo cannot be held responsible for damages if ICO is connected to a charger other than the one supplied by Ondilo. Never force a connector into the connection port. If you are having trouble to connect the connector, it probably is incompatible and should not be forced into place. Make sure the connector is compatible with the port and try again.

Please only use the opening tool supplied by Ondilo to open the upper cap of ICO. Another tool risks to damage the opening of your ICO and to reduce the waterproofness of the top of the device.

Inappropriate storage and handling can damage ICO. Do not drop ICO on the floor when carrying it out of the water. Avoid moving ICO when in operation. It is forbidden to remove ICO's top cover off when it is floating on the water. Water will enter into the system and will irreversibly damage ICO, which is not covered under the warranty terms. Ondilo cannot be held responsible if this occurs nor for any data loss. Contact www.ondilo.com/help in case your ICO needs servicing (except for routine maintenance).

If you wish to clean ICO, do not use chemicals or inflammable products. Do not use any liquids (other than water) or any abrasive sponge to clean ICO.

If a liquid comes into contact with ICO when recharging, immediately disconnect the power supply.

If the power cord is damaged, if liquid has been spilled on the product, if the product does not function correctly when instructions are respected or if the product has been dropped and is damaged, contact Ondilo assistance on www.ondilo.com/help

WARRANTY SUMMARY

This warranty (the «Warranty») applies to all countries in which the ICO product (the “Product”) has been sold on the market by ONDILO or an authorised retailer. ONDILO warrants that, at the time of its original purchase, the Product is free from defects in material, design, and workmanship subject to the following terms and conditions:

The Warranty is for the Product’s end-purchaser (the “Customer”). In no way does the Warranty limit the rights of the Customer under the mandatory provisions of applicable national law nor does it limit the rights of the Customer as outlined in his/her contract with the Product retailer/distributor.

The Warranty is valid provided that the Customer presents the Product with the original proof of purchase, such as an invoice, receipt, sales slip, warranty certificate issued by an authorised retailer accompanied by a sales slip, or proof of credit card payment if the purchase took place over the Internet. The proof of purchase must contain the date of purchase, a precise description of the Product and, if applicable, the name of the authorised retailer and serial number. In the event that the aforementioned documents cannot be presented, or that the information required is incomplete or illegible, ONDILO reserves to the right to freely deny the Warranty.

The Warranty is only valid if the Product was employed for personal use. It does not cover professional use or Products rented out for commercial purposes.

The Warranty Period is valid for a maximum of 2 (TWO) YEARS from the date the first Customer purchased the Product from ONDILO or an authorised retailer (the «Warranty Period»).

During the “Warranty Period”, ONDILO shall repair or replace the defective Product free of charge, at its sole discretion and within the limits of available stock. ONDILO shall return the repaired Product, or another Product in good working condition, to the Customer. All parts or materials that have been replaced will become the property of ONDILO.

The «Warranty Period» of a repaired or replaced Product will not be extended or renewed.

The Warranty applies to defects that arise when using the Product in accordance with the Installation and Use Guide. It does not cover Product maintenance, repairs, or part replacement due to normal wear and tear or ageing. Furthermore, the Warranty is invalid if:

The defect is attributable to the Product being: used in a manner that is inconsistent with the installation and use guide; subjected to rough treatment, extreme heat or environmental conditions, or rapid environmental or temperature changes; exposed to corrosion, oxidation, or unauthorized modifications and/or connections; subjected to repairs made by unauthorised personnel or by the Customer; subjected to repairs made with unauthorised replacement parts; improperly used or used in connection with an inappropriate power supply; exposed to an accident or forces of nature; used in a pool with untreated water; exposed to chemicals or subjected to any other act beyond the reasonable control of ONDILO;

The Customer does not inform ONDILO or the authorised Product retailer of the defect within thirty (30) days of its appearance during the «Warranty Period»;

The Product is not returned to ONDILO or the authorised Product retailer within sixty (60) days of the defect’s appearance during the «Warranty Period»;

WARRANTY SUMMARY

The Product series or identification number has been removed, deleted, damaged, altered, or rendered illegible;

The defect is the result of the Product being used with an accessory that is not manufactured or supplied by ONDILO.

The application gives dosages or tips for informational purposes only. ONDILO cannot be held liable with regards to the information given. The Application user remains the sole decision-maker with regards to the chemicals added to his swimming pool, and to its management.

The Customer agrees to return the Product in its original packaging. ONDILO is not responsible for any Product damage that occurs during transport due to inappropriate packaging. ONDILO reserves the right to request a flat-rate fee from the Customer to cover the cost of shipping and handling.

This Warranty constitutes the sole and exclusive remedy of the Client against ONDILO and ONDILO's sole and exclusive liability to the Customer in terms of defective Products. This Warranty replaces all other warranties and guarantees, whether oral, written, legal (except for those that are mandatory), contractual, quasi-delict, or otherwise. ONDILO is not liable for incidental or consequential damages or expenses. Any modification to the Warranty requires the prior written consent of ONDILO. The Warranty is subject to French law, insofar and to the extent that the peremptory norms of the law of domicile or of the Customer's head office do not provide otherwise.

TECHNICAL SPECIFICATIONS

A good internet connection is required (via Wi-Fi or Sigfox) to enjoy the full functionalities of ICO.

Dimensions :	Weight:	Connectivity :
H = 15 cm L = 11,6 cm	700 g	<u>WIFI Model :</u> 802.11 b/g/n Bluetooth 4.X USB 2.0

Power and ambient conditions

Battery input voltage: 3,7V DC.
Charger input voltage: From 100 to 240 V AC.
Charger input frequency: From 50 to 60 Hz.
Charger output frequency: 5V DC.
Operating Temperatures: From 5 to 45 °C (41°F to 113°F).
Storage temperatures: From 5 to 45 °C (41°F to 113°F).

CONTENT

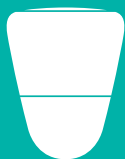

ICO



3 twist & lock sensors



1 temperature sensor integrated



1 sensor replacement tool



1 Tool to access the USB Port



5V Charger with USB cable



1 Quickstart

Required configuration

iPhone, iPad or iPod touch with iOS (from version 9.0)
Smartphone or tablet with Android (from version 5.0)



Regulatory compliance



US LISTED

Laboratory Equipment
E507374



CE conformity for Europe
ICO complies with the requirements of the European Directives 2006/95/ EC and 2004/108/EC



FCC conformity for US & Canada. ICO complies with the requirements of the US & Canada Directives Part 15 of the FCC Rules.



Information relative to the RoHS directives
This symbol means that this product respects the RoHS European (limit the use of six dangerous substances).



Disposal information in the European Union
This symbol means that, in accordance with local laws and regulations, you must dispose of your product and / or battery separately from household waste. When this product reaches the end of its life, take it to a collection point designated by the local authorities. Separate collection and recycling of your product and / or battery during disposal will help conserve natural resources and ensure that it is recycled in a manner that protects human health and the environment.



Information concerning the Eco-organism Eco Emballages
This symbol means the company printing the packaging has paid a royalty to eco-packaging.

FCC

This device complies with part 15 of the FCC Rules. Operation is subject to the following two conditions:

- (1) This device may not cause harmful interference, and
- (2) this device must accept any interference received, including interference that may cause undesired operation

Warning: Changes or modifications not expressly approved by the party responsible for compliance could void the user's authority to operate the equipment. (Part. 15.21).

This equipment has been tested and found to comply with the limits for a Class B digital device, pursuant to part 15 of the FCC Rules. These limits are designed to provide reasonable protection against harmful interference in a residential installation. This equipment generates, uses and can radiate radio frequency energy and, if not installed and used in accordance with the instructions, may cause harmful interference to radio communications. However, there is no guarantee that interference will not occur in a particular installation. If this equipment does cause harmful interference to radio or television reception, which can be determined by turning the equipment off and on, the user is encouraged to try to correct the interference by one or more of the following measures:

- Reorient or relocate the receiving antenna.
- Increase the separation between the equipment and receiver.
- Connect the equipment into an outlet on a circuit different from that to which the receiver is connected.
- Consult the dealer or an experienced radio/TV technician for help.

IC

This device complies with RSS-210 of the IC Rules. Operation is subject to the following two conditions:

- (1) this device may not cause harmful interference, and
- (2) this device must accept any interference received, including any interference that may cause undesired operation.

Warning: Changes or modifications not expressly approved by the party responsible for compliance could void the user's authority to operate the equipment. (RSS-210).

This equipment has been tested and found to comply with the limits for a Class B digital device, pursuant to RSS-210 of the IC Rules. These limits are designed to provide reasonable protection against harmful interference in a residential installation. This equipment generates, uses and can radiate radio frequency energy and, if not installed and used in accordance with the instructions, may cause harmful interference to radio communications. However, there is no guarantee that interference will not occur in a particular installation. If this equipment does cause harmful interference to radio or television reception, which can be determined by turning the equipment off and on, the user is encouraged to try to correct the interference by one or more of the following measures:

- Reorient or relocate the receiving antenna.
- Increase the separation between the equipment and receiver.
- Connect the equipment into an outlet on a circuit different from that to which the receiver is connected.
- Consult the dealer or an experienced radio/TV technician for help.

Online resources

For the latest information about ICO, visit www.ondilo.com.

To learn more about ICO support or if you need to contact us for help, visit www.ondilo.com/help

2019 Ondilo. All rights reserved.

Ondilo and ICO are registered trademarks of Ondilo. Other product and company names mentioned here may be trademarks of their respective companies.

TROUBLE SHOOTING

	Trouble	Possible reasons	Solutions
1	The QR code doesn't work	The QR code doesn't match your ICO	Check that you scan the QR code inside your ICO original box
		The QR code in the box isn't readable	Please contact our assistance service with your ICO serial number.
		I don't have access to internet on my phone	Verify the connectivity of your phone
2	My ICO doesn't switch ON	The battery charge is low	Charge your ICO for a minimum of 6h
		I didn't press long enough on the button	Please take the lid off and check that ICO is ON
3	My ICO doesn't connect to Wi-Fi	Your ICO is out of range from the Wi-Fi network	Please refer to the assistance sheet dedicated to the Wi-Fi extension in your garden: www.ondilo.com/assistance
		Your Wi-Fi network is configured in 5Ghz	ICO is compatible only with a Wi-Fi network of 2,4 Ghz, verify the setup of your internet Box
		Your internet Box or your Wi-Fi hotspot is switched OFF	Verify your internet box status
4	My ICO doesn't connect	The login data are wrong	Check your Wi-Fi connection informations (Wi-Fi network name, secure key)
		Your ICO doesn't connect to internet	Confirm that your internet connection is valid
5	I can't install the ICO App	Your iOS or Android version it's not compatible with your App	ICO Application System requirements: iPhone, iPad or iPod Touch with iOS (from 9.0 version), smartphone or tablet with Android (from 4.3 version)

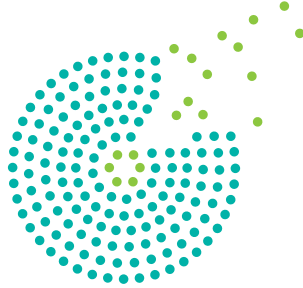

Ondilo

ondilo.com

ZA La Pile
162, Avenue Robert Schuman
13 760 Saint-Cannat
contact@ondilo.com
+33 9 72 56 46 04