

E.PRO Filterpumpe

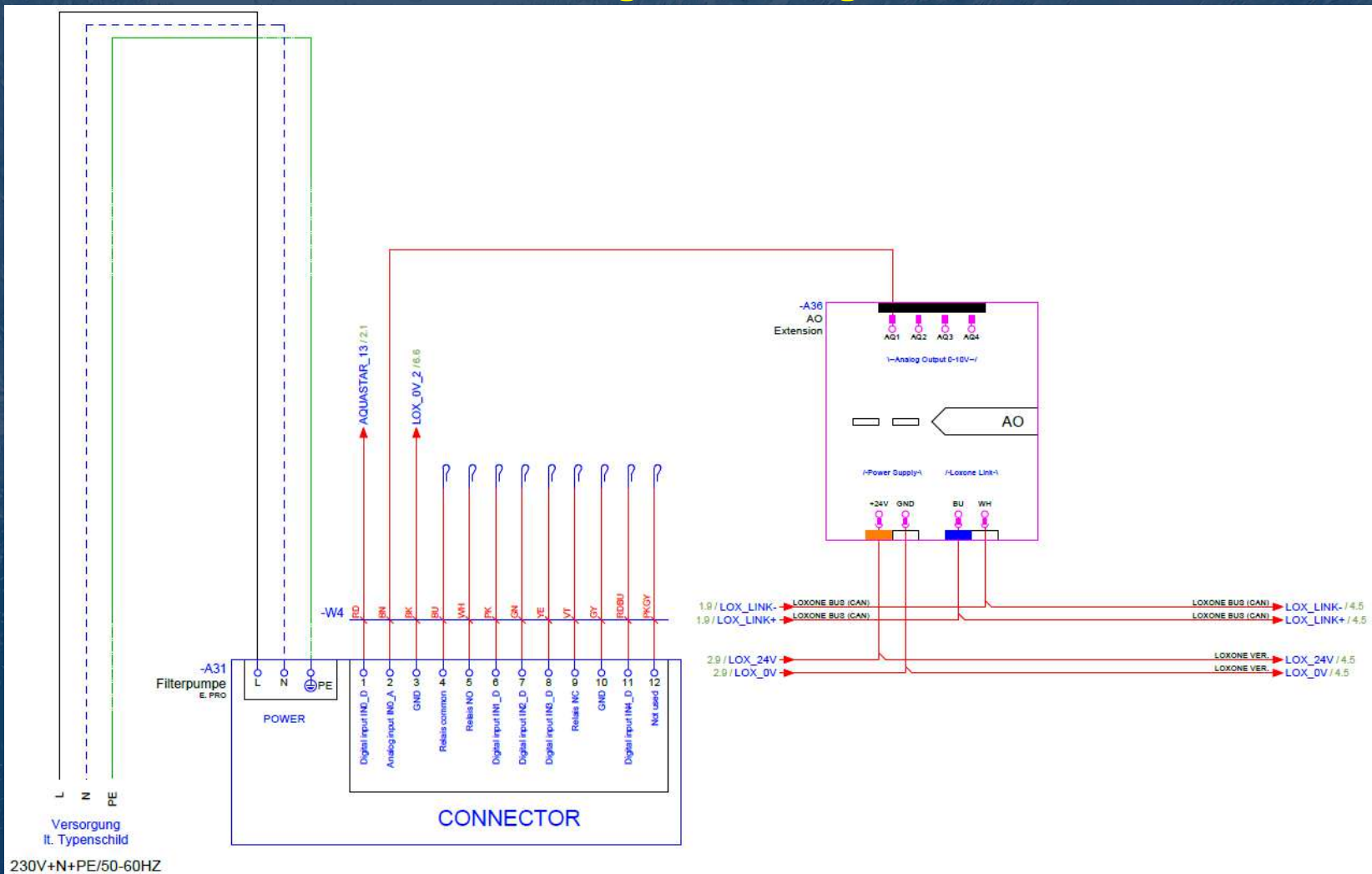

- Stufenlose Regelung
- Tatsächliche Regelung des Volumenstromes
- Ist wassergekühlt und dadurch flüsterleise
- Hocheffizienter Permanentmagnetmotor
Wirkungsgrad bis zu 88%
- Kommunikation mit Loxone über 0-10V
Analogsignal -> AO-Extension
- **Darf nie ohne Wasser betrieben werden**

E.PRO Filterpumpe



E.PRO Filterpumpe - Zubehör

- 7300489 | Datenkabel 16m

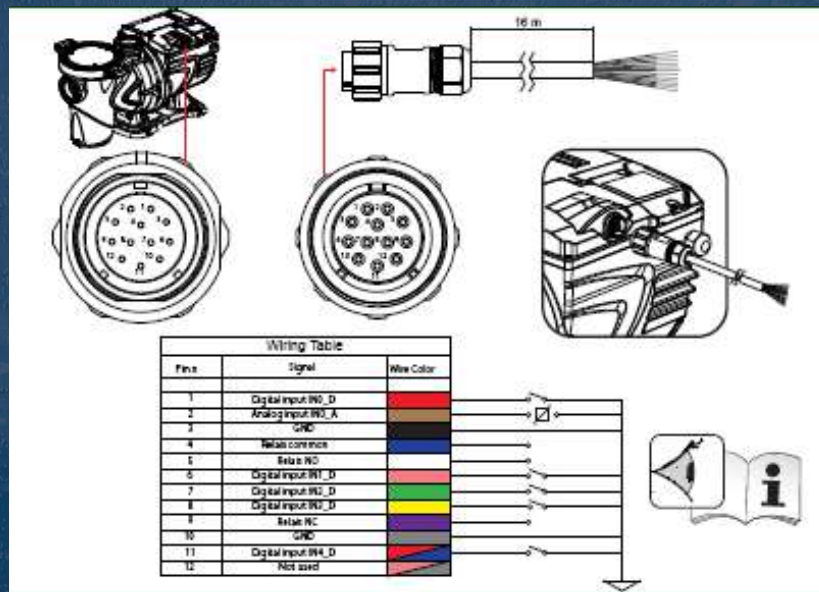

- <https://shop.peraqua.com/Pumpen/Smart-Pumpen/Schwimmbadpumpe-E-Pro-150-drehzahleregelt-selbstansaugend-Innengewinde-2-27m-h-bei-15-4m-230V-P1-1-25kW-P2-1-1kW-eingebauter-grosser-Vorfilter-Schwimmbadpumpe-E-Pro-150-drehzahleregelt-selbstansaugend-Innengewinde-2-27m-h-bei-15-4m-230V-P1-1-25kW-P2-1-1kW.html>

E.PRO Filterpumpe - Detailsinstellungen

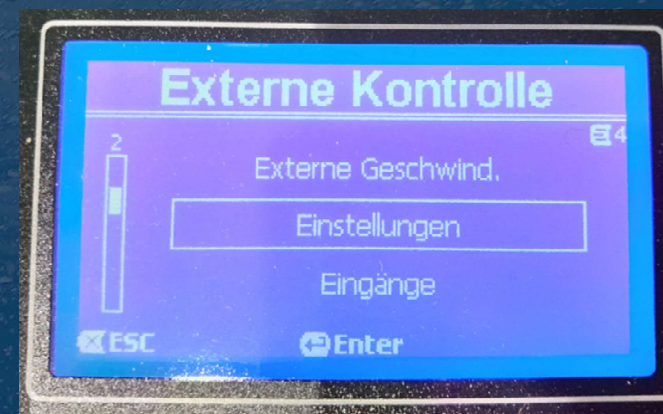
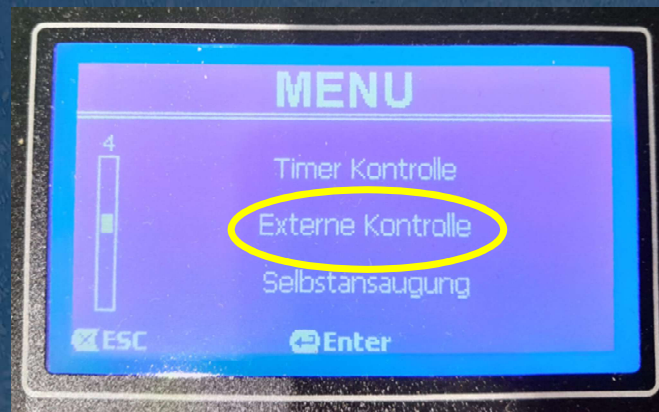



E.PRO Filterpumpe - Detailsinstellungen

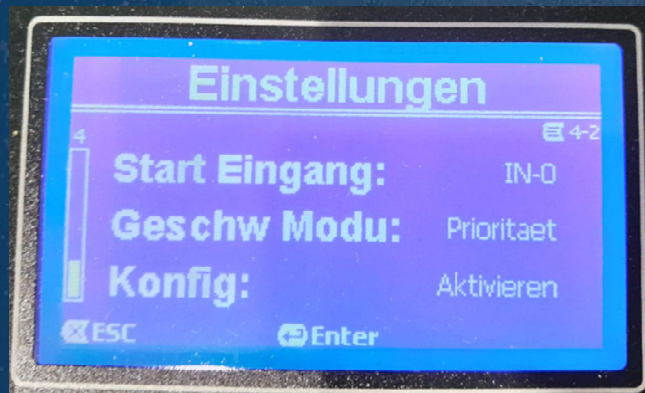
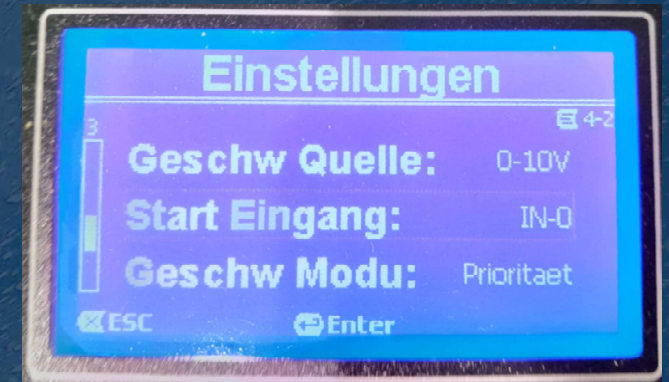
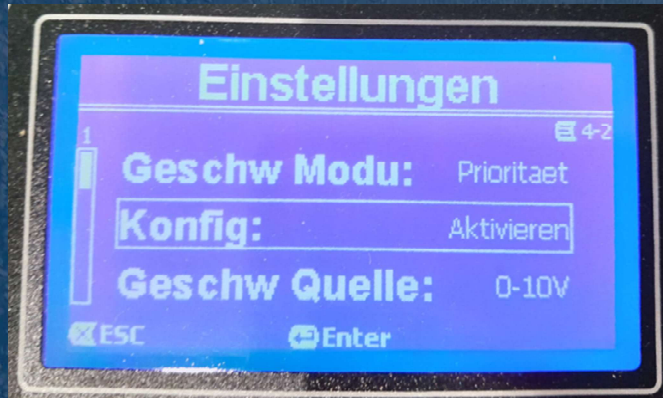

E.PRO Filterpumpe - Detailsinstellungen

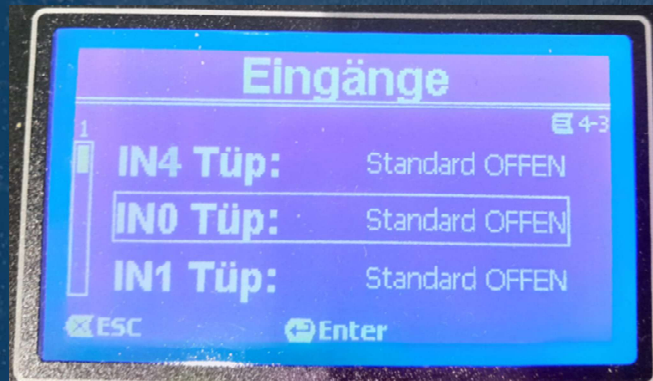
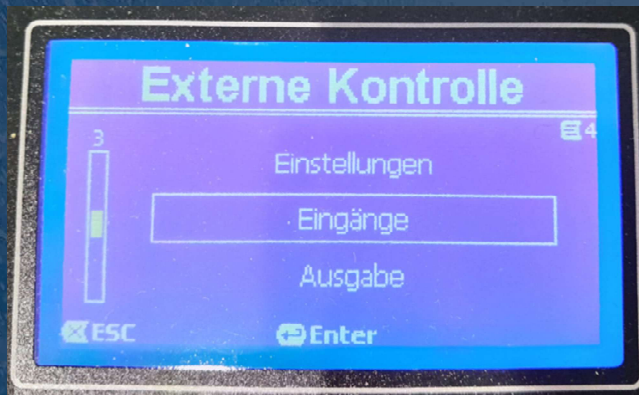

E.PRO Filterpumpe - Detailsinstellungen

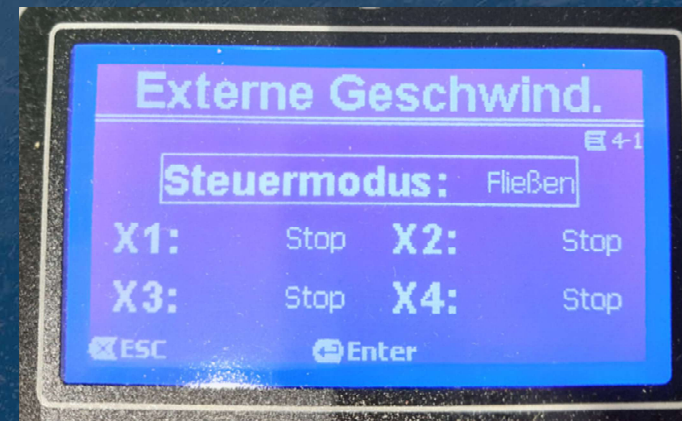
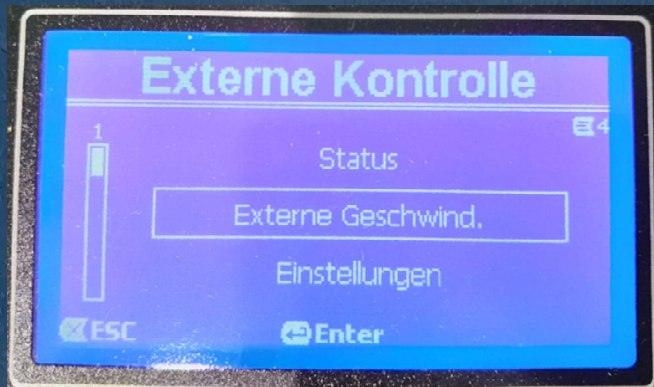

E.PRO Filterpumpe - Detailsinstellungen

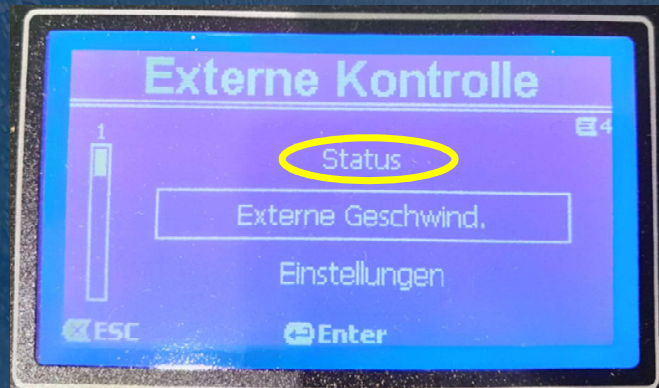

Pumpenfreigabe über AS 13/14



Spannung der AO-Extension

0V ... kleinstes Regelminimum 6m³/h

10V ... größter Volumenstrom, limitiert durch Pumpenleistung/Verrohrung



E.PRO Filterpumpe - Detailsinstellungen

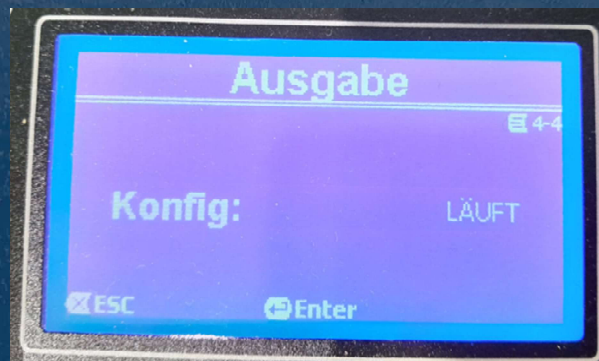
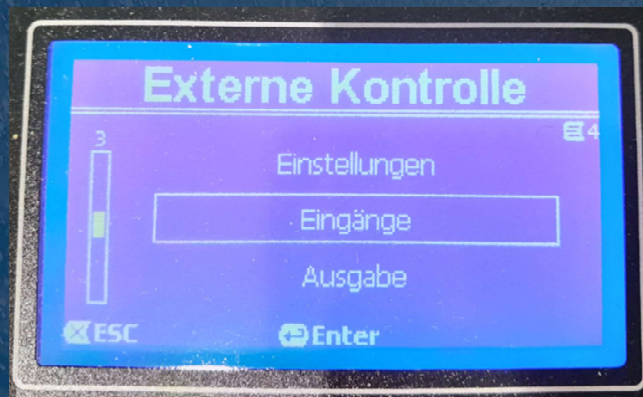



E.PRO Filterpumpe - Detailsinstellungen

